

LITTLE JOE PARTS LIST

NEWCO ENTERPRISES INC,
3650 NEW TOWN BLVD SAINT CHARLES, MO 63301
1-800-325-7867



NEWCO CONTACT INFORMATION

ADDRESS

NEWCO ENTERPRISES INC,
3650 NEW TOWN BLVD
SAINT CHARLES, MO 63301

CUSTOMER SERVICE PHONE

1-800-325-7867

TECHNICAL SERVICE PHONE

1-800-556-3926

FAX

1-636-925-0029

WEBSITE

newcocooffee.com

CUSTOMER SERVICE AND SALES EMAIL

sales@newcocooffee.com

MAINTENANCE INFORMATION

Machine Model _____

Serial Number _____

Company Information and Phone Number

WARRANTY

This warranty supersedes all other previous warranties that are currently in manuals. Newco warrants equipment manufactured by it for 1 year parts and labor. Dispensers and Display Tablets - 1 year parts only. Electronic Circuit and Control Boards- 1 year parts and labor.

These warranty periods run from the date of sale Newco warrants that the equipment manufactured by it will be commercially free of defects in material and workmanship existing at the time of manufacture and appearing within the applicable warranty period. This warranty does not apply to any equipment, component or part that was not manufactured by Newco or that, in Newco's judgment, has been affected by misuse, neglect, alteration, improper installation or operation, relocation or reinstallation, improper maintenance or repair, incorrect voltage applied to the unit at any time, damage or casualty. This warranty does not apply to any equipment failures related to poor water quality, excessive lime and chlorine and non-periodic cleaning and descaling. Warranty is null and void if muriatic or any other form of hydrochloric acid is used for cleaning or deliming. In addition, this warranty does not apply to replacement of items subject to normal use including but not limited to user replaceable parts such as faucet seat cups, sight gauge tubes, washers, o-rings, tubing, seals and gaskets.

This warranty is conditioned on the Buyer 1) giving Newco prompt notice of any claim to be made under this warranty by telephone at (800) 556-3926 or by writing to **3650 New Town Blvd, Saint Charles, MO 63301**; 2) if requested by Newco, shipping the defective equipment prepaid to an authorized Newco service location; and 3) receiving prior authorization from Newco that the defective equipment is under warranty.

THE FOREGOING WARRANTY IS EXCLUSIVE AND IS IN LIEU OF ANY OTHER WARRANTY, WRITTEN OR ORAL, EXPRESS OR IMPLIED, INCLUDING, BUT NOT LIMITED TO, ANY IMPLIED WARRANTY OF EITHER MERCHANTABILITY OR FITNESS FOR A PARTICULAR PURPOSE. The agents, dealers or employees of Newco are not authorized to make modifications to this warranty or to make additional warranties that are binding on Newco. Accordingly, statements by such individuals, whether oral or written, do not constitute warranties and should not be relied upon.

If Newco determines in its sole discretion that the equipment does not conform to the warranty, Newco, at its exclusive option while the equipment is under warranty, shall either 1) provide at no charge replacement parts and/or labor (during the applicable parts and labor warranty periods specified above) to repair the defective components, provided that this repair is done by a Newco Authorized Service Representative; or 2) shall replace the equipment or refund the purchase price for the equipment.

THE BUYER'S REMEDY AGAINST NEWCO FOR THE BREACH OF ANY OBLIGATION ARISING OUT OF THE SALE OF THIS EQUIPMENT, WHETHER DERIVED FROM WARRANTY OR OTHERWISE, SHALL BE LIMITED, AT NEWCO'S SOLE OPTION AS SPECIFIED HEREIN, TO REPAIR, REPLACEMENT OR REFUND.

In no event shall Newco be liable for any other damage or loss, including, but not limited to, lost profits, lost sales, loss of use of equipment, claims of Buyer's customers, cost of capital, cost of down time, cost of substitute equipment, facilities or services, or any other special, incidental or consequential damages.

TABLE OF CONTENTS

Servicing the Machine -----	5
Draining the Hot Water Tank -----	5
Flavor Ring Instructions -----	6
Machine Parts -----	8
Display Assembly with Panel -----	8
Waste Bin -----	9
Drip Tray -----	10
Drain Tube -----	11
Reservoir -----	12
Brewing Mechanism -----	14
Dispense Area -----	17
Back of the Machine -----	19
Water Inlet -----	20
Tank with Major Components -----	21
3-way Valve Assembly Components -----	23
Right Side -----	24
Control Board Assembly -----	25
Wire Harnesses -----	26
Wiring Diagram -----	27

SERVICING THE MACHINE

DRAINING THE HOT WATER TANK



WARNING:

DISCONNECT MACHINE FROM POWER & ALLOW HOT WATER TO COOL COMPLETELY BEFORE ATTEMPTING TO DRAIN WATER TANK!

Perform the following steps to drain the hot water tank.

Note: Waste bin is designed to hold the water released by the system once all spent pods have been removed.

1. Disconnect brewer from power & allow hot water tank to cool completely.
2. Remove waste bin once machine has cooled.
3. Locate the drain plug behind the waste bin in the lower right corner of the back wall.
4. Gently pull on the plug & extend the drain tube.
 - a. The tube clamp attached to drain tube may need to be angled to maneuver it through drain plug opening.
5. Remove the drain plug from the end of the drain tube.
6. Direct drain tube into a container or drain. Ensure your hands are away from the end of the tube.
7. Slide the tube clamp to release the water.
8. Once the water has finished draining, slide the clamp back to close off the drain tube.
9. Insert the drain plug back onto the drain tube.
10. Push the drain tube back into the machine & push the drain plug back into its opening.

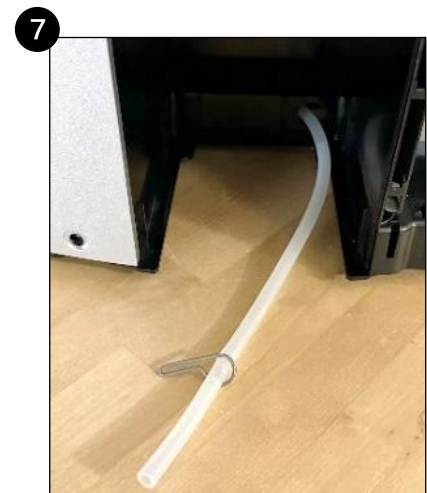
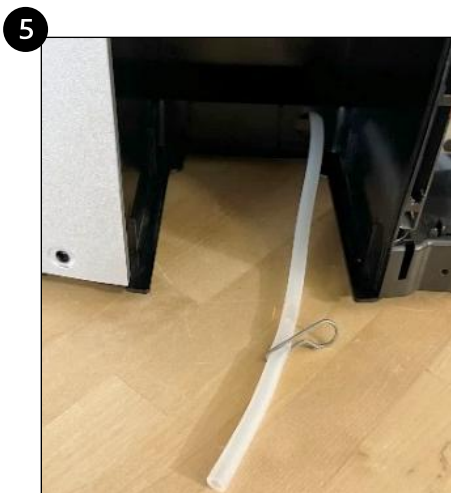
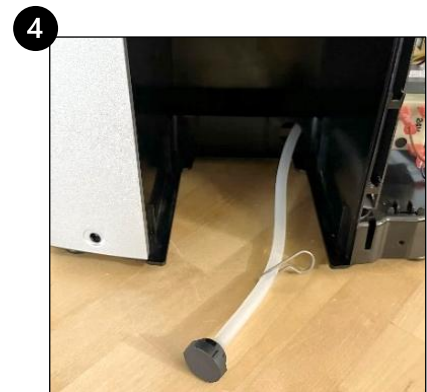

Direct tube into a container or drain
BEFORE sliding tube clamp!

SERVICING THE MACHINE

FLAVOR RING INSTRUCTIONS

For the Little Joe Spray Head Assembly

See pg. 14 for components and PNs related to spray head assembly



CAUTION:

Toggle power **OFF** & read all instruction carefully before servicing your machine!

For optimal brewing performance, please keep the flavor ring installed. If there are occurrences of heavier gram weight pods remaining in the upper chamber, then the flavor ring may be removed.

Removing the Ring

1. Ensure brewer is powered **OFF** & fully cooled.
2. Open brew mech & pull flavor ring out of silicone gasket.
3. Ensure flavor ring is clean & dry before storing.

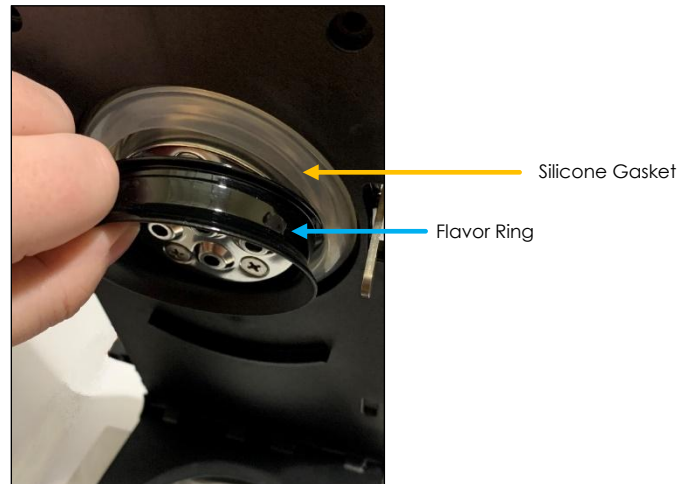

Replacing the Ring

1. Ensure brewer is powered **OFF** & fully cooled.
2. Open the brew mech.
3. Use a Phillips Head screwdriver to remove the 5 screws holding the spray head assembly in place.
4. Gently pull on the silicone gasket to remove the spray head assembly from brew mech.
5. Remove the silicone gasket from the spray head.

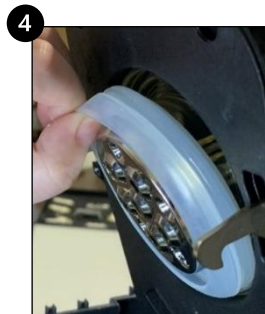
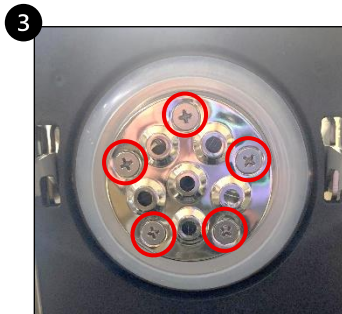

SERVICING THE MACHINE

FLAVOR RING INSTRUCTIONS



CAUTION:

Toggle power **OFF** & read all instruction carefully before servicing your machine!

Replacing the Ring

- Align the spray head & the flavor ring as shown.
- Insert the flat edges of the spray head & the flavor ring into the groove of the silicone gasket. Ensure the wider end of the flavor ring is on the same side as the wider groove in the silicone gasket.

6



7

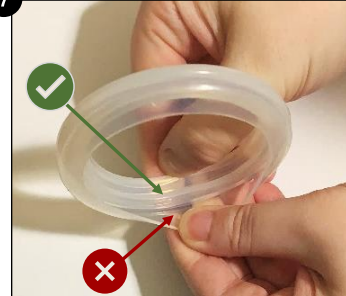

- Work the silicone gasket around the silver metal spray head and flavor ring until all edges are fully seated in the groove.
- Identify where the screw holes are on the brewer spray head (*clear plastic, circled*) & align with the screw holes of the metal spray head assembly with the flavor ring facing **OUTWARDS**.

8



9

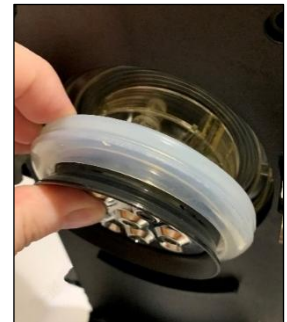
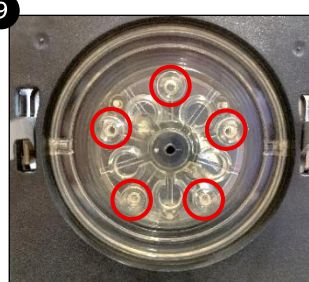

- Push the spray head assembly into the brew mech & hold.
- Use a Phillips Head screwdriver to re-install the previously removed 5 screws.
- Open & close the brew mech several times, checking to make sure the mech latches properly.



WARNING:

If the brew mech does not close properly, remove the spray head & start again. Failure to fully tighten screws may cause leakages & impact brewer performance!

11



12



MACHINE PARTS

DISPLAY ASSEMBLY WITH PANEL

IMPORTANT COMPONENT INFORMATION

Brewers with Serial Number SP00006000 & HIGHER were manufactured with an updated Control Board Assembly & an updated Display Panel Assembly.

The updated Display Panel Assembly is NOT compatible with the previous model of Control Board Assembly (Used in Brewers with Serial Numbers PRIOR TO SP00006000)

See chart below to determine which Display Panel Assembly is compatible with your model brewer.



If Brewer Serial Number is SP00005999 or LOWER:

COMPLETE ASSEMBLY WITH PANEL
English Only
PN 153237-SV

COMPLETE ASSEMBLY WITH PANEL
Multi-Language
PN 1533274-SV

If Brewer Serial Number is SP00006000 or HIGHER:

COMPLETE ASSEMBLY WITH PANEL
English Only
PN 153330-SV

COMPLETE ASSEMBLY WITH PANEL
Multi-Language
PN 153328-SV

Serial Number	Control Board in Brewer	Compatible Display Panel Assembly (English Only)	Compatible Display Panel Assembly (Multi Language)
SP00005999 or LOWER	PN: 152906	PN: 153237-SV	PN: 1533274-SV
SP00006000 or HIGHER	PN: 153332	PN: 153330-SV	PN: 153328-SV

Brewer Serial Number is listed on the Serial Tag, located on the back panel of machine.

MACHINE PARTS

WASTE BIN

Waste Bin Assembly
PN 152948

Pass-Through Waste Bin Assembly
PN: 153256



Magnet
PN: 121301
Magnet Cover
PN: 782160



Drop Down Cup Holder
PN: 152931

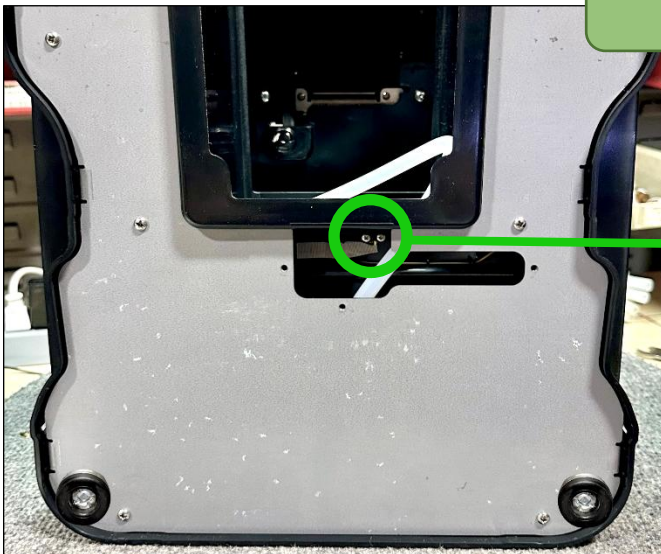

Waste Bin Sensor
PN: 152993

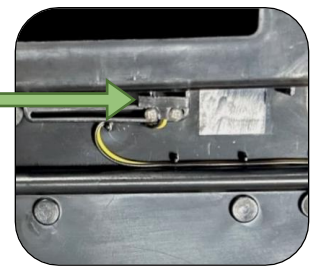

Sensor is located below the small cover plate on bottom of brewer

MACHINE PARTS

DRIP TRAY

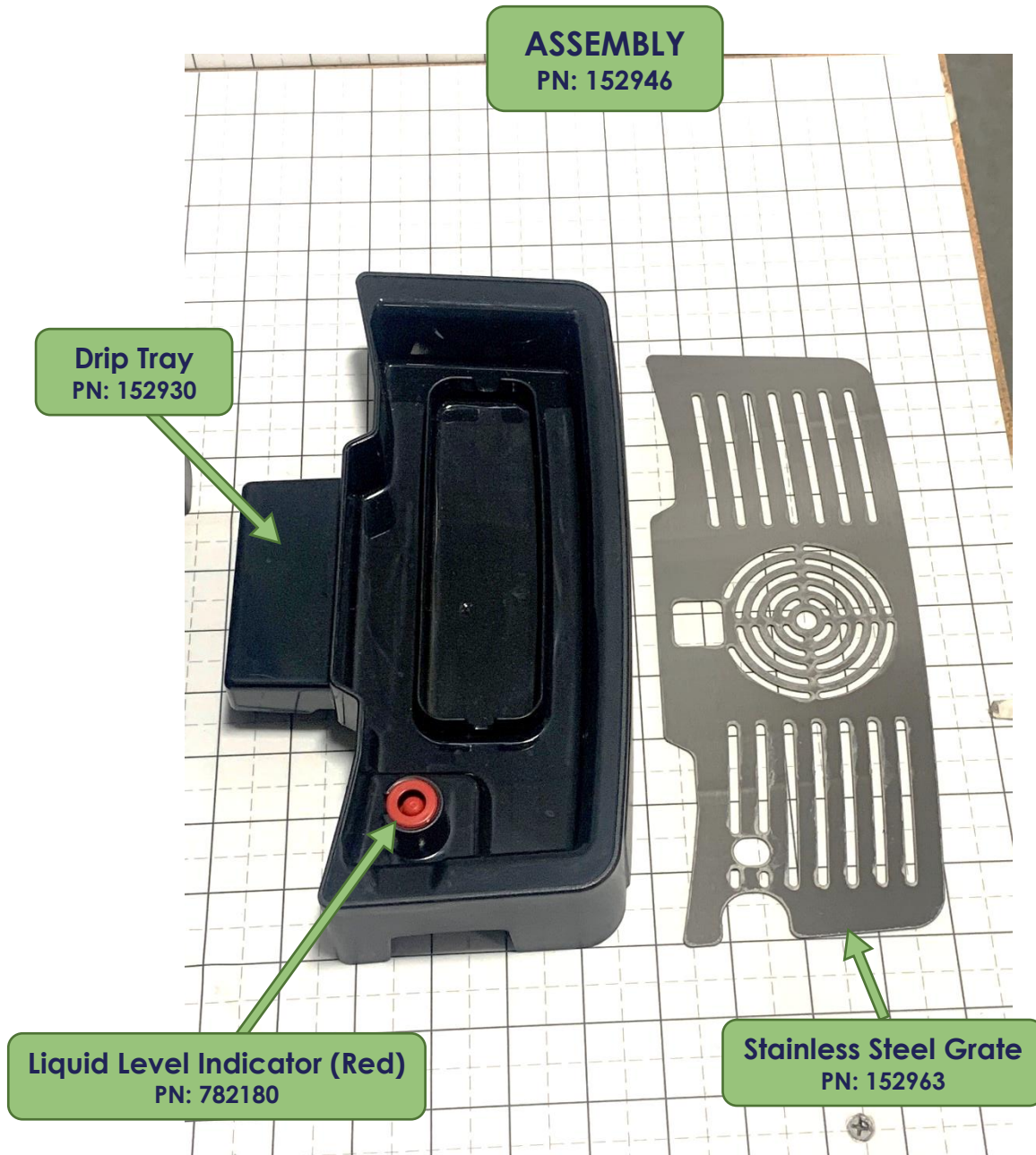

MACHINE PARTS

DRAIN TUBE

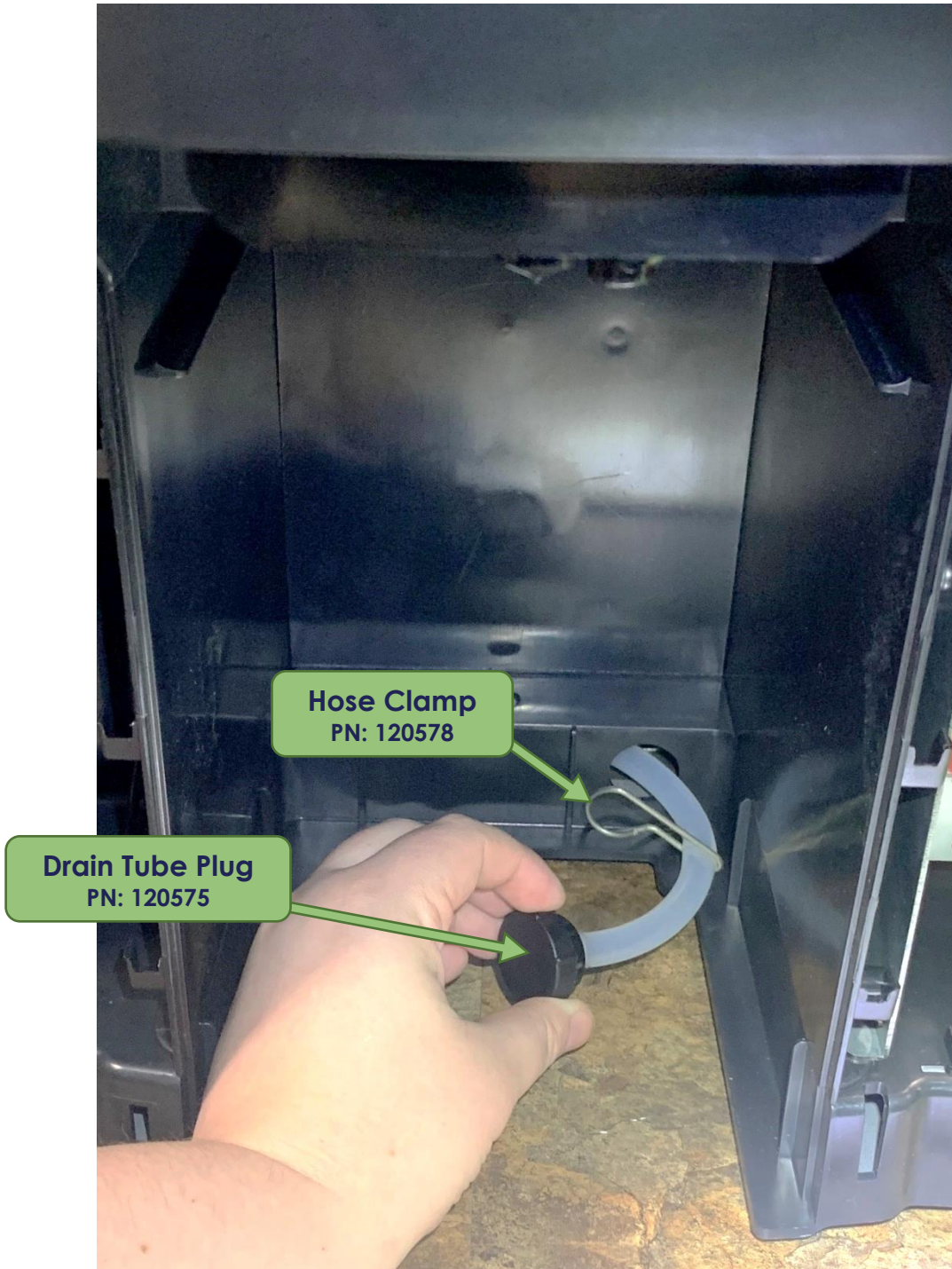

MACHINE PARTS

RESERVOIR

! IMPORTANT COMPONENT INFORMATION

Brewers manufactured up to Serial Number SP00004069 were built with Reservoir Assembly PN:153273 & Reservoir Detection Switch PN:153220.

See note at bottom of page for more information.

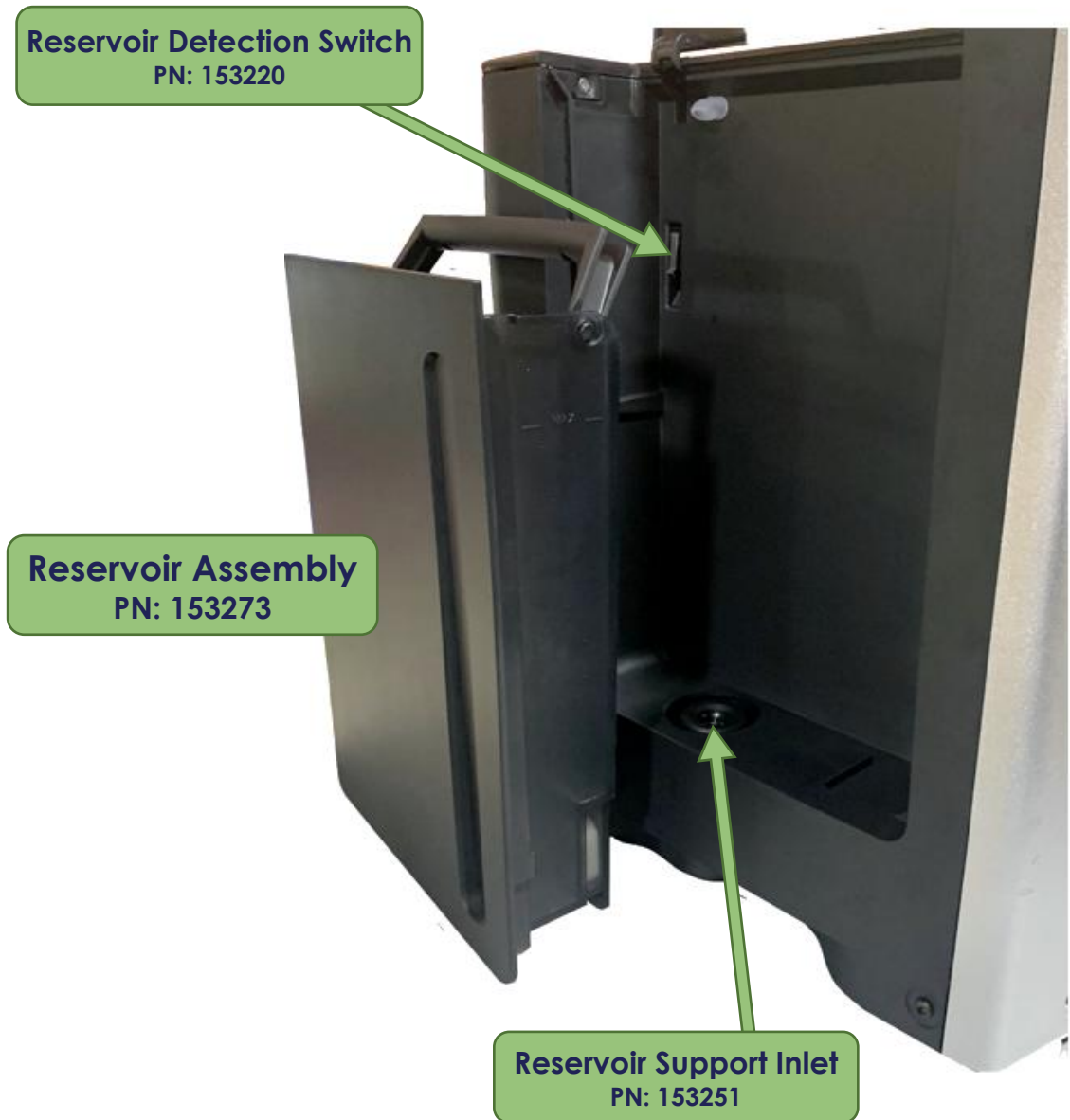

Note:

Reservoir Assembly PN:153273 (shown above) is only compatible with Reservoir Detection Switch PN:153220.

Reservoir Assembly PN:153273 is NOT compatible with the Reservoir Detection Switch shown on the following page.

If your brewer uses the black plastic reservoir PN:153273, ensure that you request PN:153220 when ordering a replacement Reservoir Detection Switch.

MACHINE PARTS

RESERVOIR

! IMPORTANT COMPONENT INFORMATION

Brewers manufactured AFTER Serial Number SP00004069 were built with Reservoir Assembly PN:153324 & Reservoir Detection Switch PN:153404.

See note at bottom of page for more information.



Note:

Reservoir Assembly PN:153324 (shown above) is only compatible with Reservoir Detection Switch PN:153404.

Reservoir Assembly PN:153324 is NOT compatible with the Reservoir Detection Switch shown on the following page.

If your brewer uses the clear plastic reservoir PN:153324, ensure that you request PN:153324 when ordering a replacement Reservoir Detection Switch.

MACHINE PARTS

BREWING MECHANISM

Complete Spray Head Assembly
PN 153020

Comes with Gasket, Spray Head & Screws

Spray Head Gasket
PN: 153021

Spray Head
PN: 153022

Flavor Ring
PN: 153222

Pod Holder Cup
PN: 152757

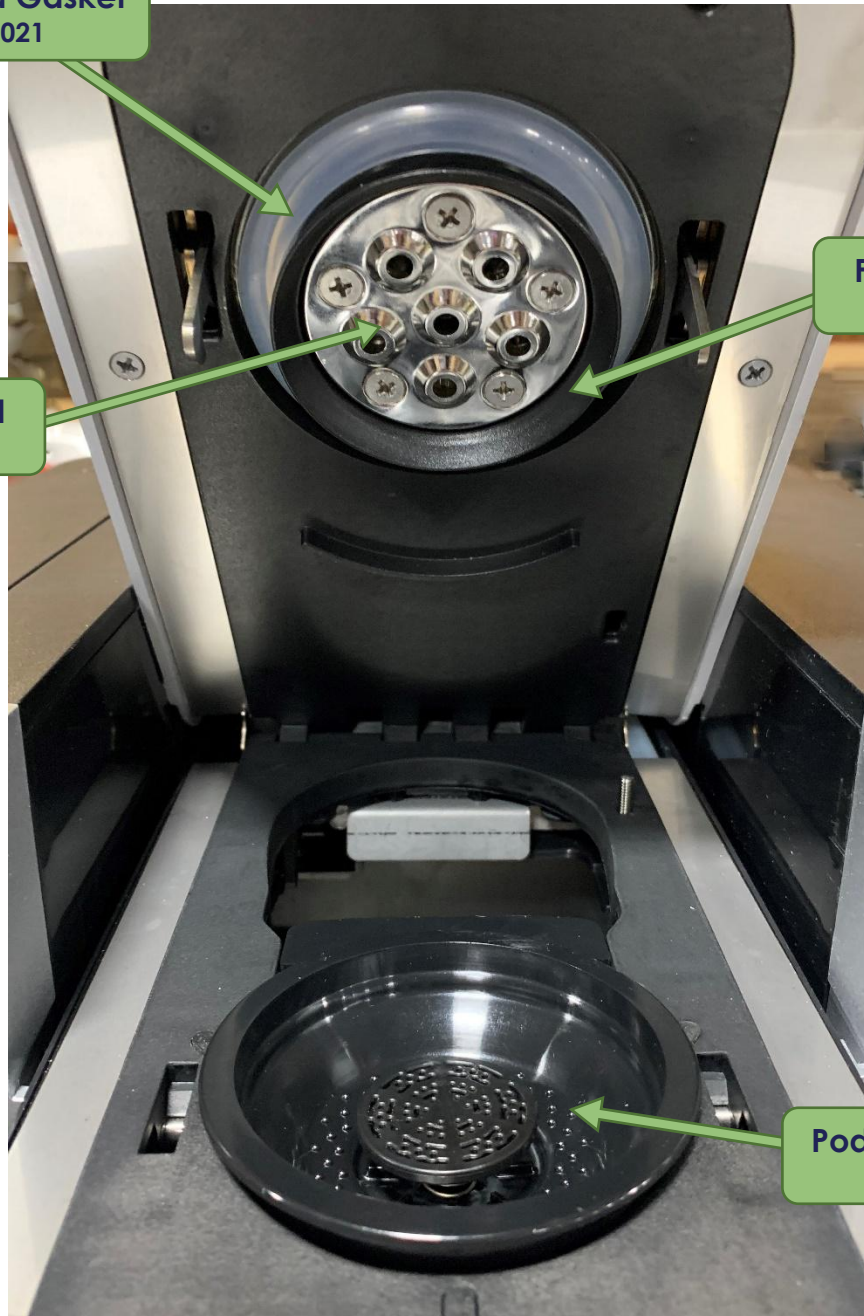

MACHINE PARTS

BREWING MECHANISM

Limit Switch w/Harness & Bracket



Limit Switch trip point

The Limit Switch Bracket is installed onto the Brew Mech Upper.

Limit Switch Bracket PN: 152979

- Screw (2x)
PN: 103969
- Nut (2x)
PN: 103970



Limit Switch with Harness PN: 152992

MACHINE PARTS BREWING MECHANISM

Pod Flipper Spring
PN: 152902

Pod Flipper Spring is installed onto brewer base **BELOW** the Brew Mech.

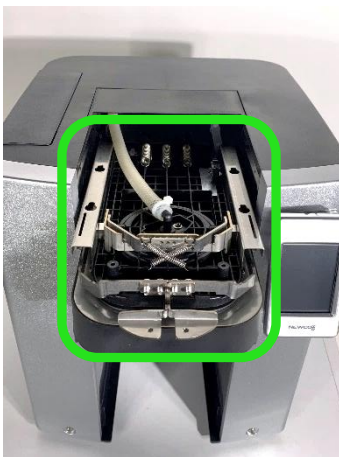

Brew Mech must be removed from brewer to access Flipper Lever.

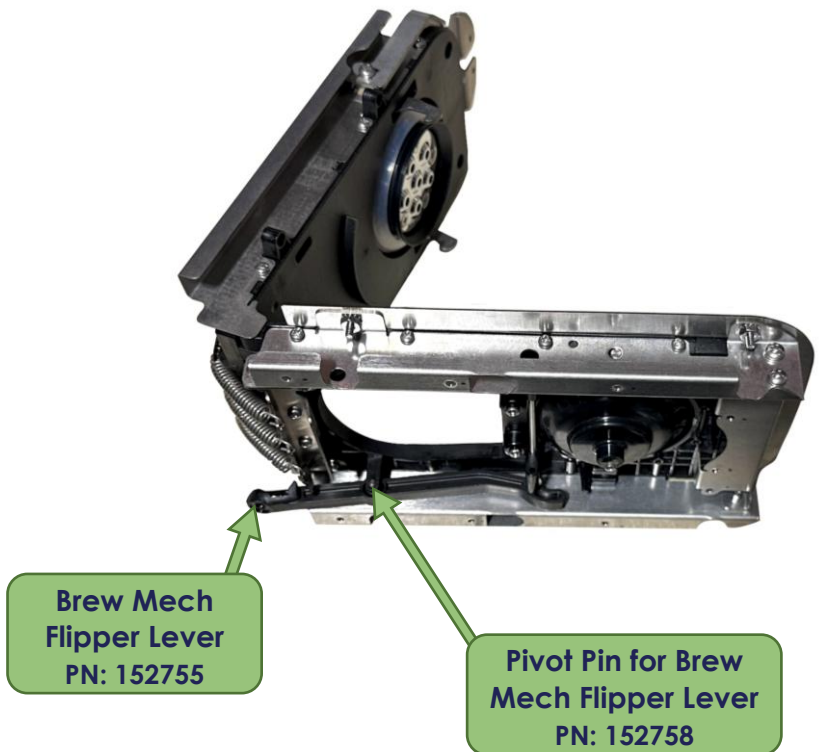

**Brew Mech
Flipper Lever**
PN: 152755

**Pivot Pin for Brew
Mech Flipper Lever**
PN: 152758

MACHINE PARTS DISPENSE AREA



Product Nozzle
PN: 767254



Funnel Assembly W/O-Ring
PN: 780592

Funnel Retainer
PN: 780041

MACHINE PARTS DISPENSE AREA

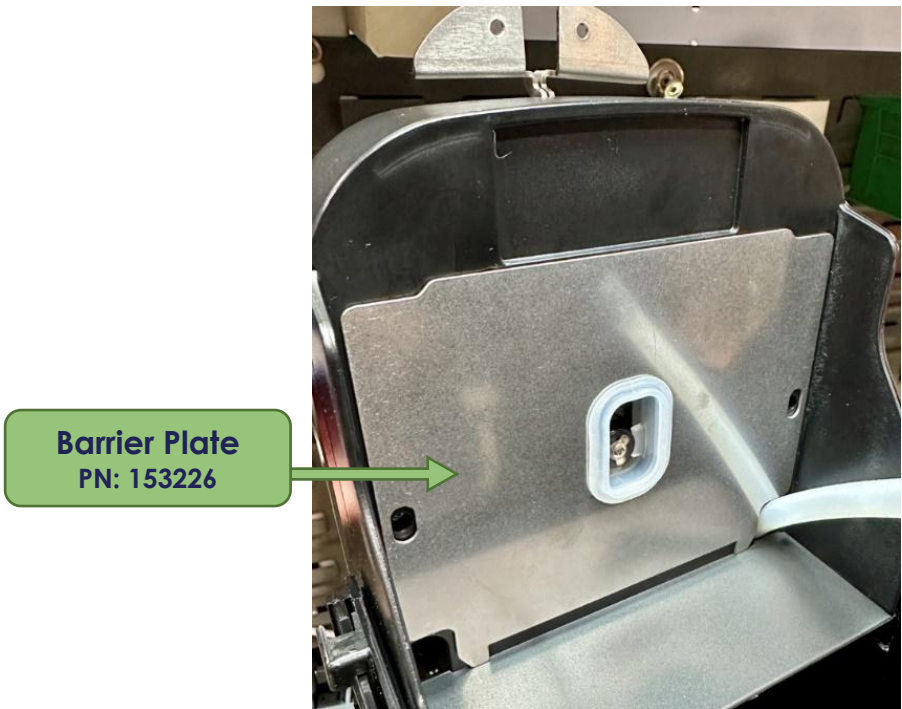

Barrier Plate is located **UNDER** the Funnel Assembly.

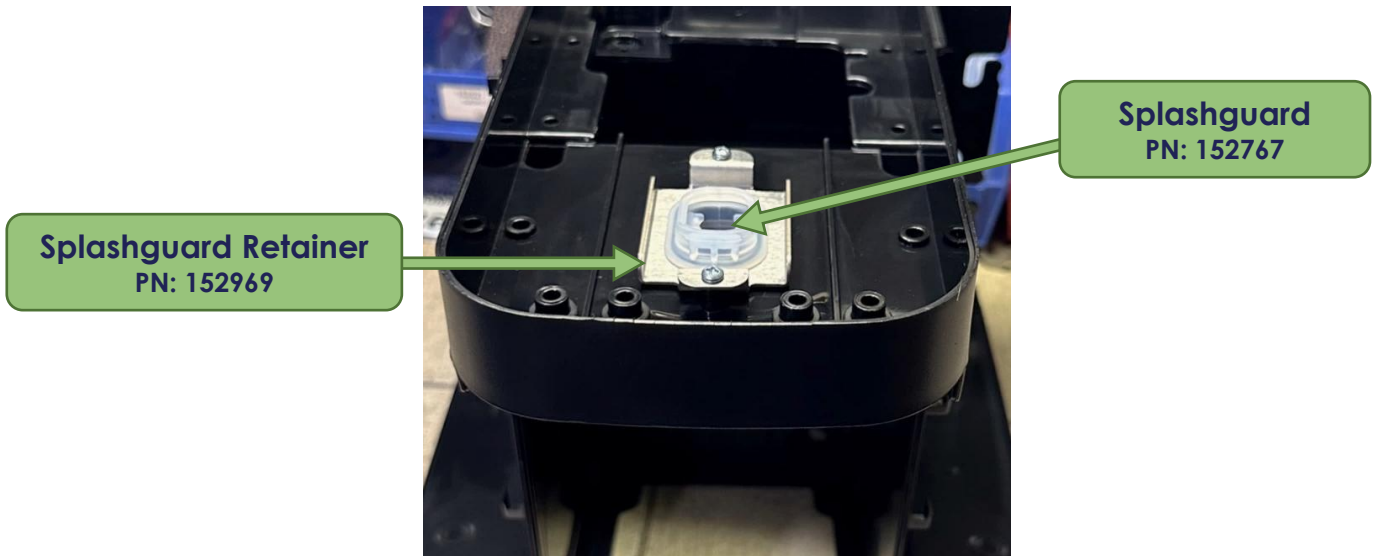

Splashguard & Splashguard Retainer are installed **UNDER** the Brew Mech.

MACHINE PARTS

BACK OF THE MACHINE



MACHINE PARTS

WATER INLET



Inlet Valve
PN: 201175

Pour Over Mode:

Inlet Gasket
PN: 111178

Inlet Cap Disc
PN: 153259

Plastic Nut
PN: 111177

Plumbed In Mode:

Inlet Gasket
PN: 111178

Inlet Fitting
PN: 101377

Plastic Nut
PN: 111177

Inlet Elbow
PN: 100177

Inlet Assembly
PN: 111775
Includes Fitting, Gasket,
Plastic Nut, & Elbow

MACHINE PARTS

TANK WITH MAJOR COMPONENTS

1700W Tank (US)
PN: 153325

PN includes replacement
tank assembly & install
instructions.

**3 Way Valve w/ One
Straight Barb Fitting &
One 90° Barb Fitting
(Hot Water Valve)**

PN: 153313

See page 23 for more details.

**3 Way Valve w/ Two
Straight Barb Fittings
(Coffee Valve)**

PN 153312

See page 23 for more details.

Water Pump
PN: 153024

Flowmeter Assembly
PN: 152952

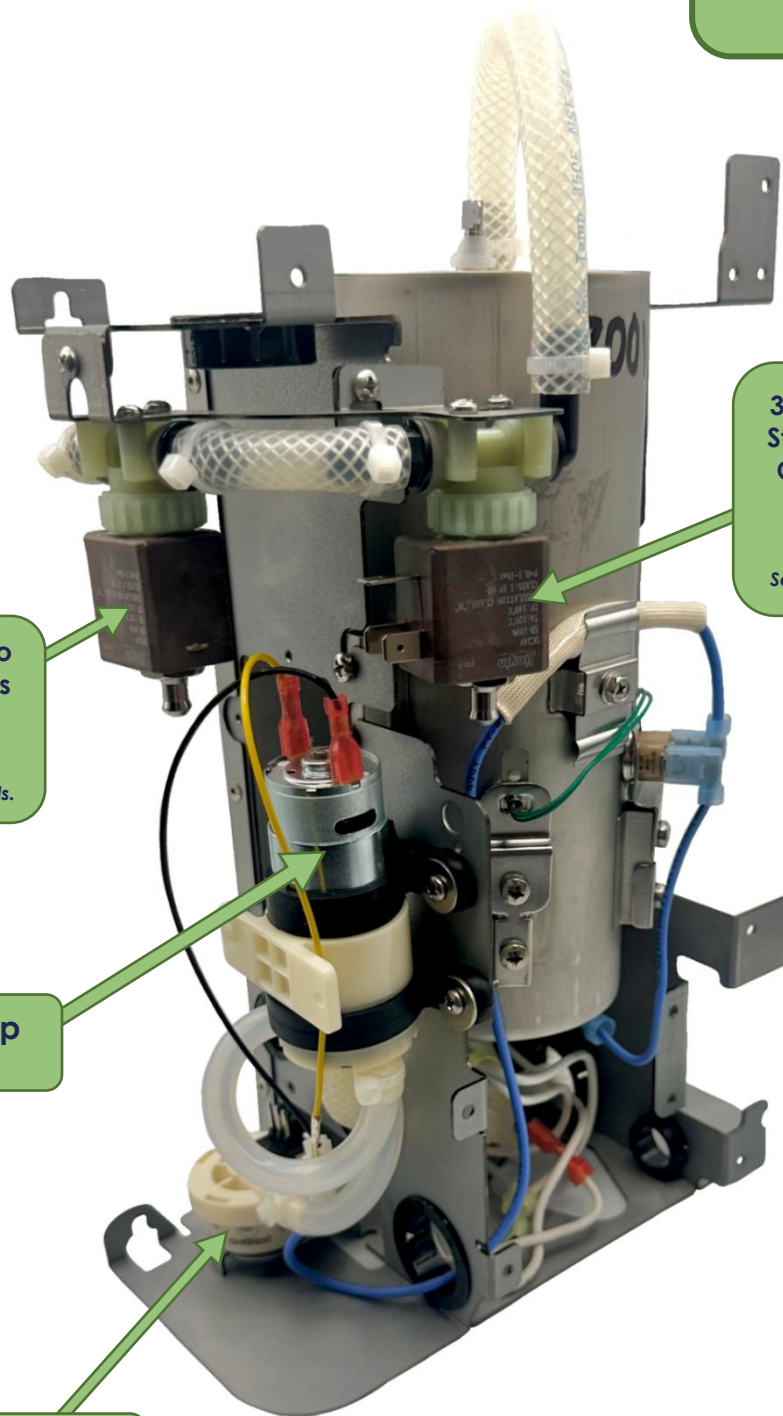

MACHINE PARTS

TANK WITH MAJOR COMPONENTS

1400W Tank (Can)
PN 153267

**3 Way Valve w/ Two
Straight Barb Fittings
(Coffee Valve)**
PN 153312
See page 23 for more details.

Water Pump
PN: 153024

**3 Way Valve w/ One
Straight Barb Fitting &
One 90° Barb Fitting
(Hot Water Valve)**
PN: 153313
See page 23 for more details.

Flowmeter Assembly
PN: 152952

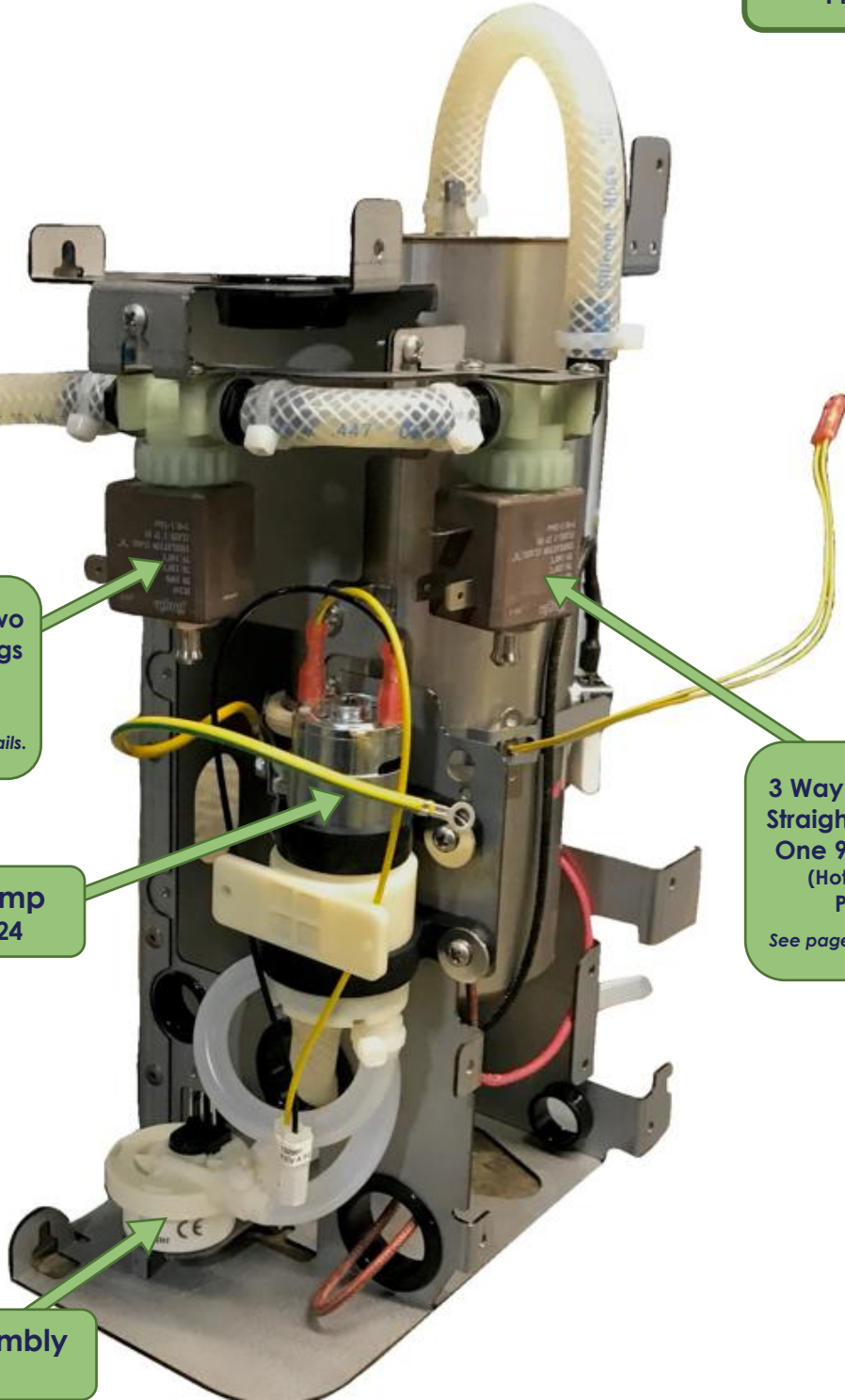

MACHINE PARTS

3-WAY VALVE ASSEMBLY COMPONENTS

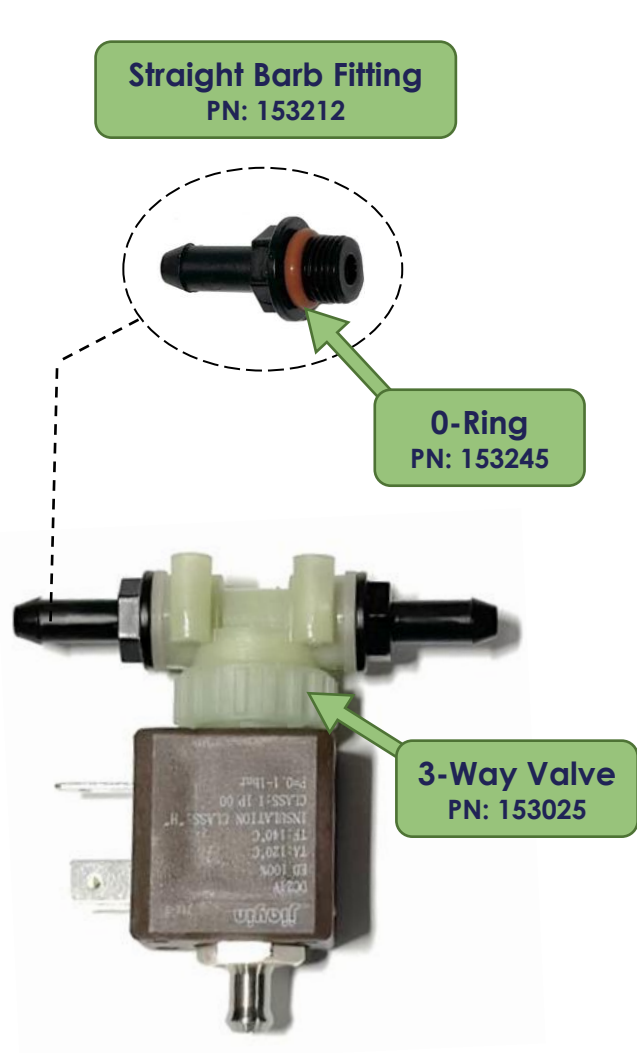

**3 Way Valve w/ Two
Straight Barb Fittings**
PN: 153312



**3 Way Valve w/ One Straight
Barb Fitting & One 90° Barb Fitting**
PN: 153313

MACHINE PARTS RIGHT SIDE

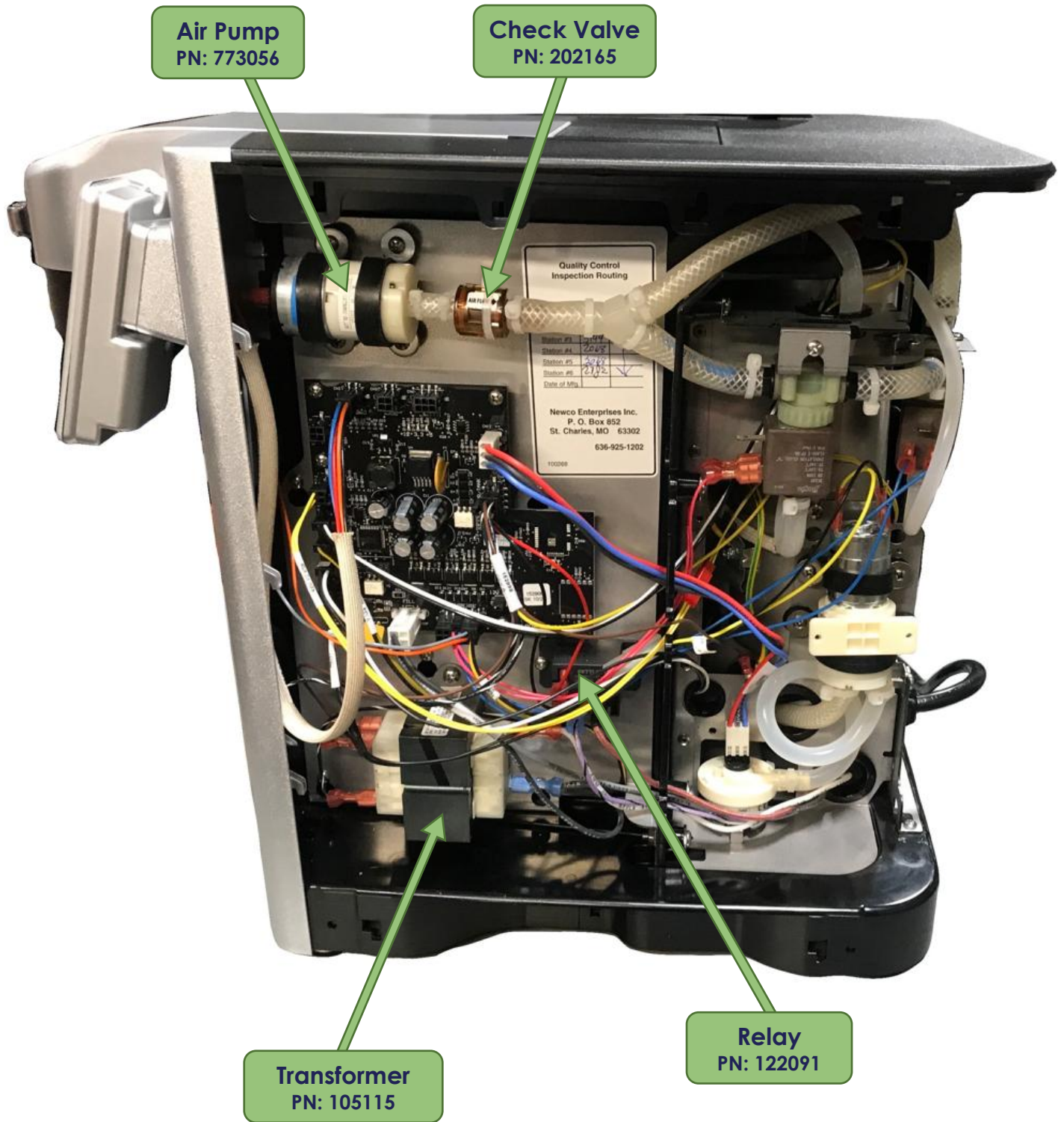

MACHINE PARTS

CONTROL BOARD ASSEMBLY

IMPORTANT COMPONENT INFORMATION

Brewers with Serial Number SP00006000 & HIGHER were manufactured with an updated Control Board Assembly & an updated Display Panel Assembly.

The updated Display Panel Assembly is NOT compatible with the previous model of Control Board Assembly (Used in Brewers with Serial Numbers PRIOR TO SP00006000)

See chart below to determine which Control Board Assembly is compatible with your model brewer.

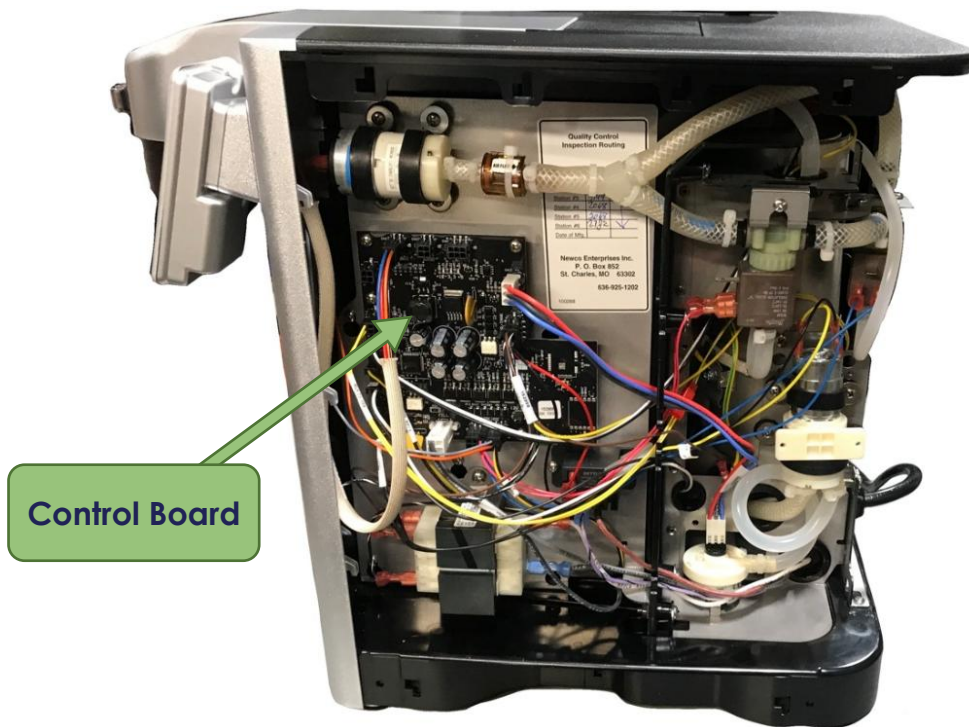

If Brewer Serial Number is SP00005999 or LOWER:

Control Board
PN: 152906

If Brewer Serial Number is SP00006000 or HIGHER:

Control Board
PN: 153332

Serial Number	Control Board in Brewer	Compatible Display Panel Assembly (English Only)	Compatible Display Panel Assembly (Multi Language)
SP00005999 or LOWER	PN: 152906	PN: 153237-SV	PN: 1533274-SV
SP00006000 or HIGHER	PN: 153332	PN: 153330-SV	PN: 153328-SV

Brewer Serial Number is listed on the Serial Tag, located on the back panel of machine.

MACHINE PARTS

CONTROL BOARD ASSEMBLY

Wire Harnesses

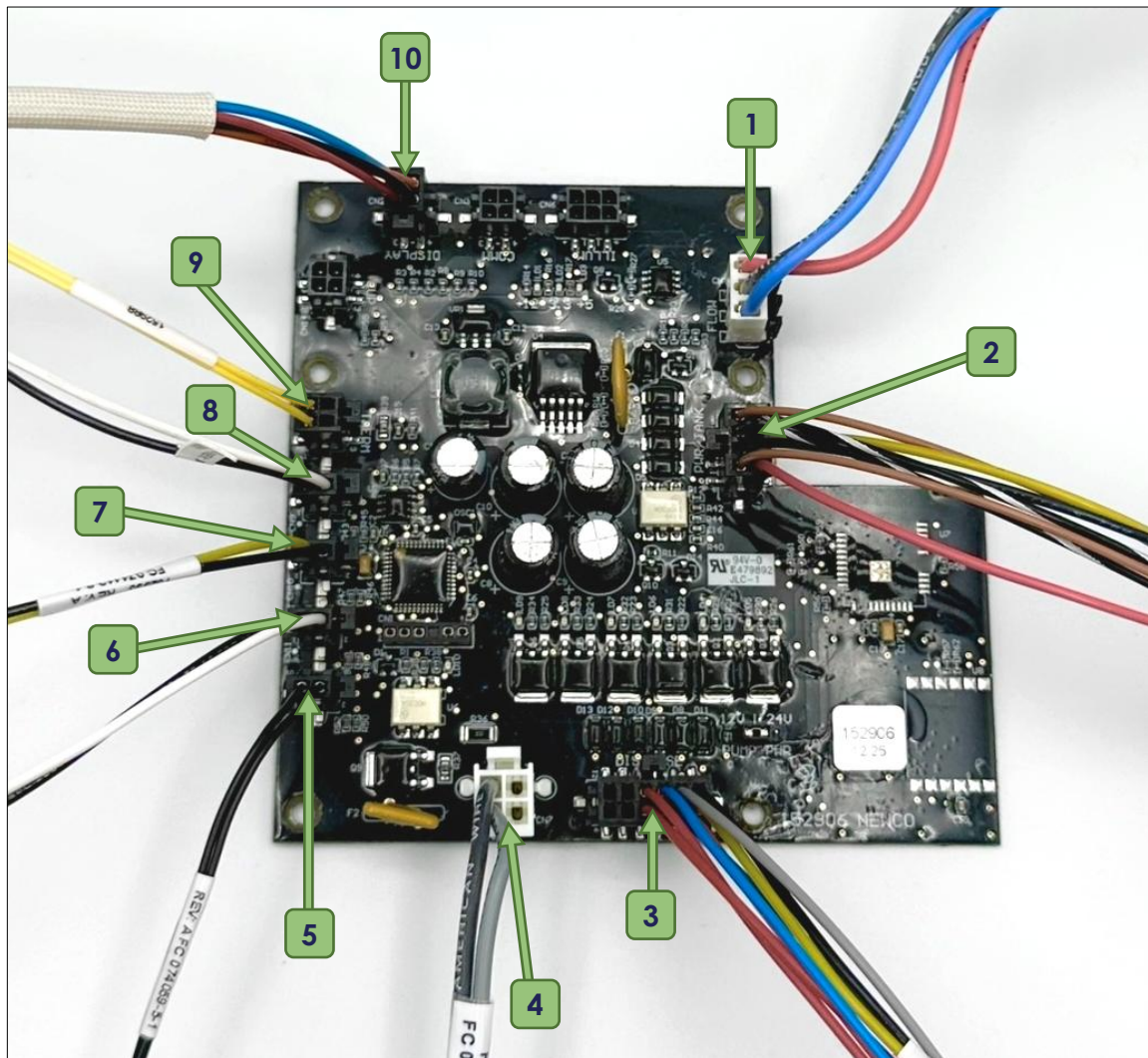

Wire Harnesses			
1	152990	Flow Meter Harness	1 EA
2	152998	Relay/Transformer Harness	1 EA
3	152995	Air/ Solenoid Harness	1 EA
4	152997	Inlet Valve / PCB Harness	1 EA
5	152994	Prox/Microswitch Harness	1 EA
6	See pg. 12-13	Reservoir Detection Switch	1 EA
7	152993	Magnet Sensor Harness (Waste Bin Sensor)	1 EA
8	152992	Limit Switch Harness (Brew Mech)	1 EA
9	152988	Thermistor Harness	1 EA
10	See pg. 8	Display Panel Assembly	1 EA

WIRING DIAGRAMS

Wire colors subject to change based on availability.

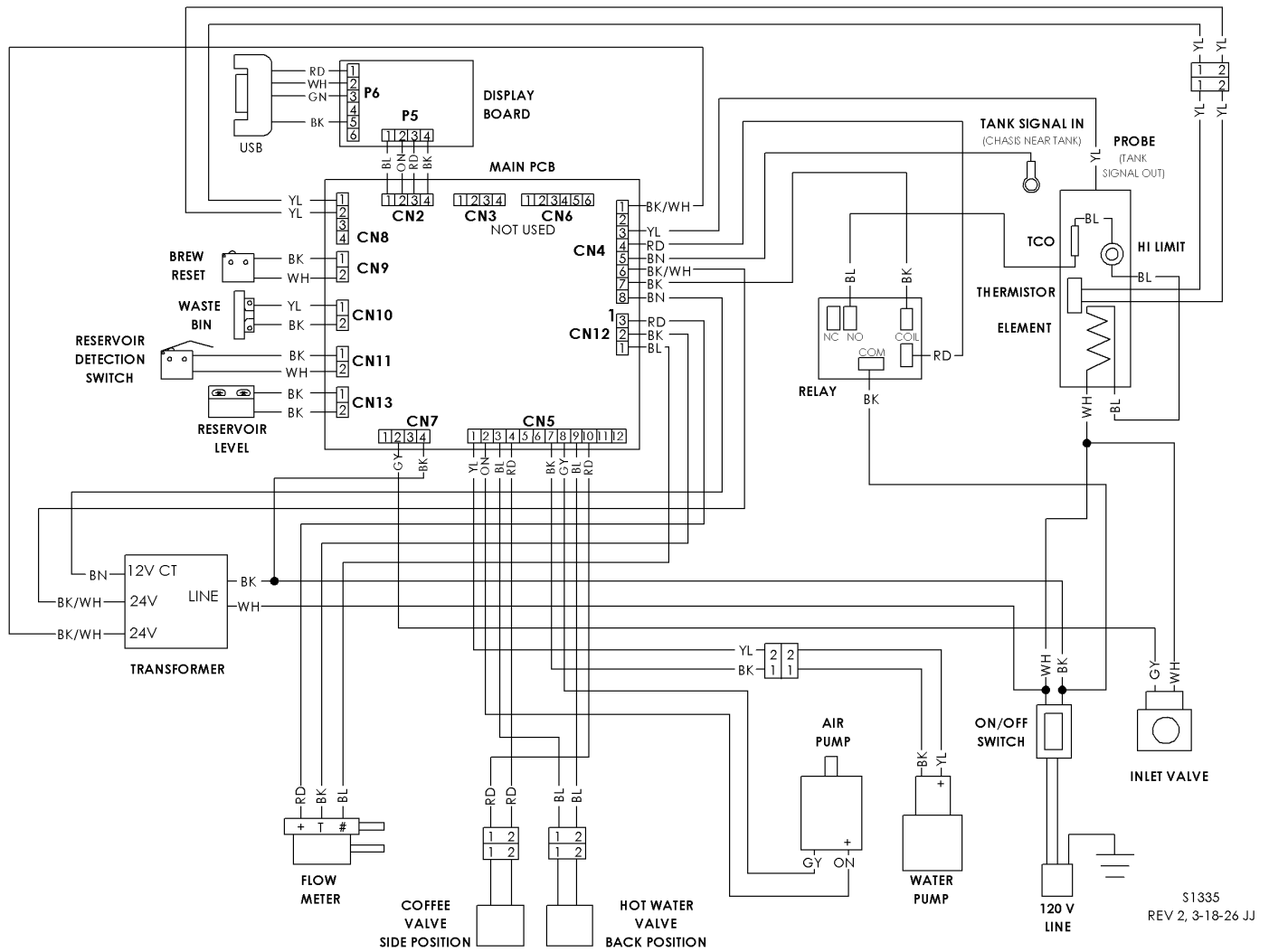

WIRING DIAGRAMS

OLD STYLE TANK ASSEMBLY

Wire colors subject to change based on availability.

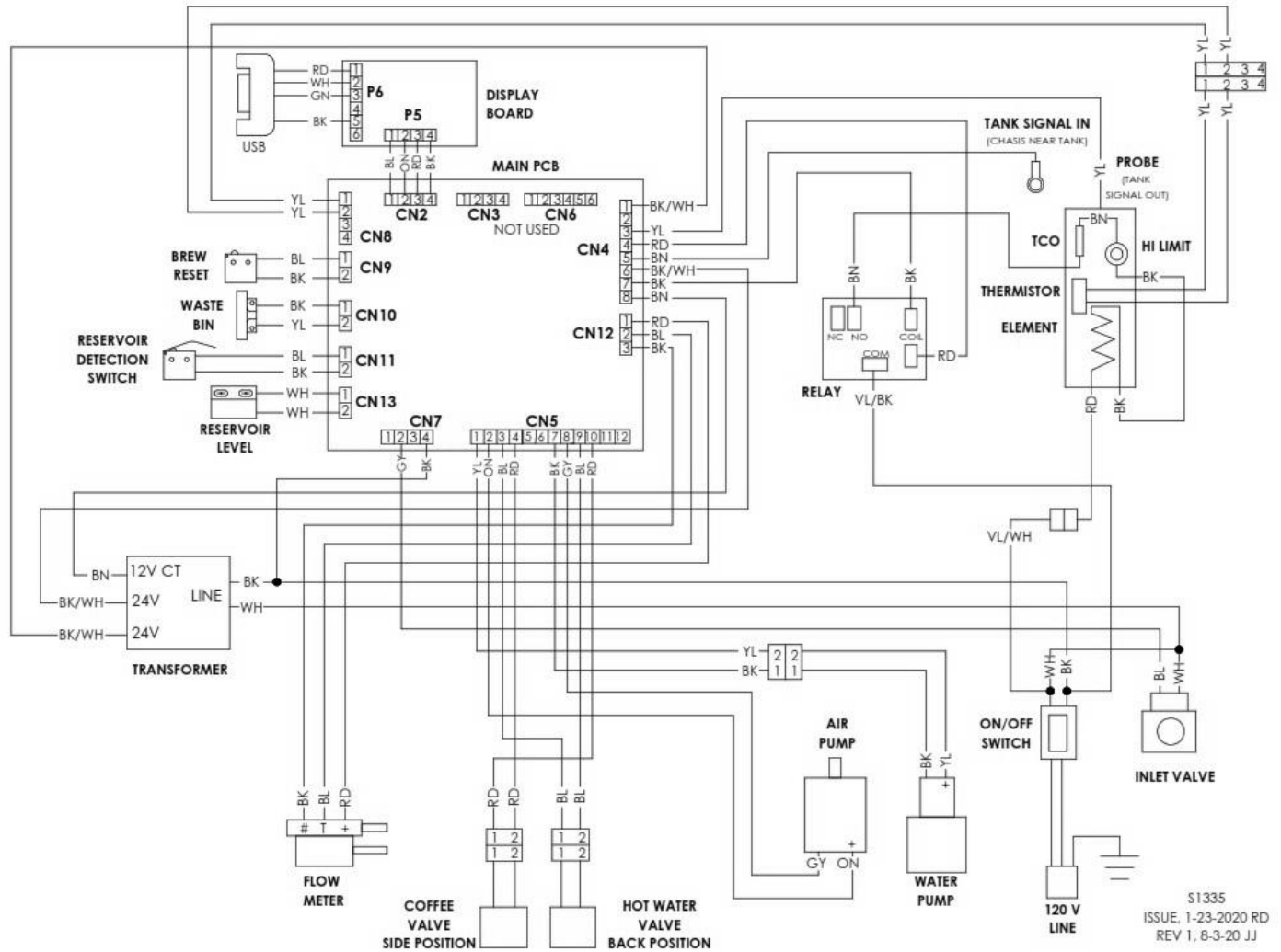

S1335
 ISSUE, 1-23-2020 RD
 REV 1, 8-3-20 JJ