

FRESH CUP SERIES PARTS LIST

NEWCO ENTERPRISES INC,
3650 NEW TOWN BLVD SAINT CHARLES, MO 63301
1-800-325-7867



Fresh Cup Touch
PN 782150



Fresh Cup 4
PN 782185

All servicing and repairs must be done by an authorized technician.

Before servicing, machine power must be disconnected and hot water tank must be drained. See page 14 for draining the hot water tank.

NEWCO CONTACT INFORMATION

ADDRESS

NEWCO ENTERPRISES INC,
3650 NEW TOWN BLVD SAINT CHARLES, MO 63301

CUSTOMER SERVICE PHONE

1-800-325-7867

TECHNICAL SERVICE PHONE

1-800-556-3926

FAX

1-636-925-0029

WEBSITE

newcocooffee.com

CUSTOMER SERVICE AND SALES EMAIL

sales@newcocooffee.com

MAINTENANCE INFORMATION

Machine Model _____

Company Information and Phone Number

ALWAYS disconnect machine power and water supply line **BEFORE** servicing your machine.

Newco updates parts based on availability.

Customers with special orders may have parts not included in this document.

Note: in Canada repairs are to be done by certified electricians or brewer must be reinspected to maintain applicable certification.

TABLE OF CONTENTS

PANEL REMOVAL -----	4
EXTERNAL PANELING -----	5
BACK OF THE MACHINE -----	6
BREWER BASE-----	7
WASTE BIN AND DRIP TRAY ASSEMBLY PN 782179 -----	8
DISPENSE AREA -----	9
WATER INLET AND STRAINER ASSEMBLIES -----	10
INLET TUBE -----	11
FRESH CUP 4 FRONT PANEL -----	12
FRESH CUP TOUCH FRONT PANEL -----	13
DRAINING THE HOT WATER TANK -----	14
TANK REMOVAL -----	15
TANK ASSEMBLY PN 780619-----	16
PUMP AND BRACKET ACCESS -----	18
TANK LID ASSEMBLY PN 780647 -----	20
UNIVERSAL 2 BREW MECH PN 780585-----	22
61MM BREW MECH PN 780622-----	26
ELECTRONICS ACCESS-----	28
TRANSFORMER AND POWER CORD -----	29
FRESH CUP 4 CONTROL BOARD -----	30
FRESH CUP 4 WIRING DIAGRAM -----	31
FRESH CUP TOUCH CONTROL BOARD -----	32
FRESH CUP TOUCH WIRING DIAGRAM -----	33

PANEL REMOVAL

Before beginning any servicing on the brewer, ensure power is turned off and disconnected. Once brewer is cool, see page 14 for draining the hot water tank. After hot water tank has been drained, servicing may begin.

1. Loosen 2 screws (PN 105110) then remove cover panel

2. Remove 2 screws (PN 105110) from the rear of the side panel

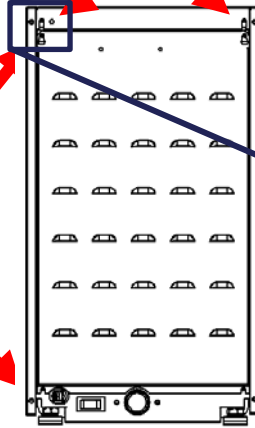
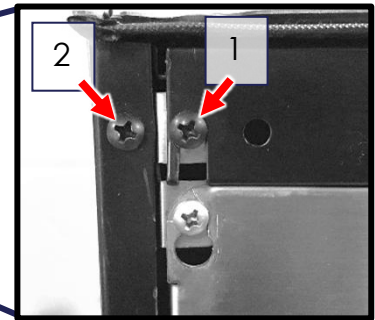

3. Slide panel to rear of machine

4. Lift panel up and release top flange

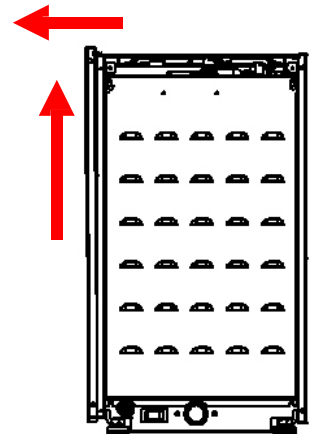
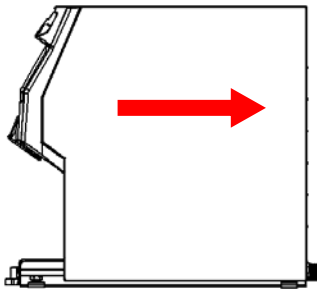

5. Slide panel down

6. Slide panel forward to release

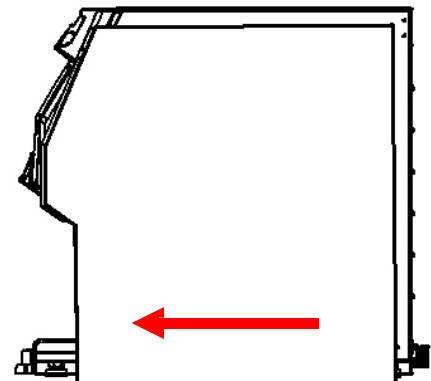
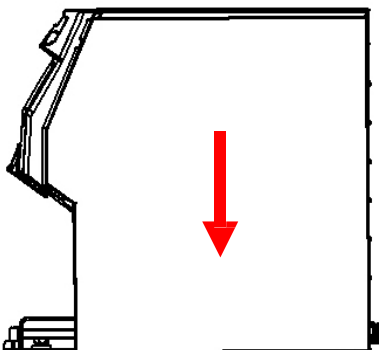

EXTERNAL PANELING



1	780612-BPC	TOP COVER	1 EA
N/S	780614-BPC	LEFT EXTERNAL SIDE PANEL	1 EA
2	780615-BPC	RIGHT EXTERNAL SIDE PANEL	1 EA

BACK OF THE MACHINE



3	780442	MACHINE BACK PANEL	1 EA
4	111377	APPLIANCE FOOT	4 EA

BREWER BASE

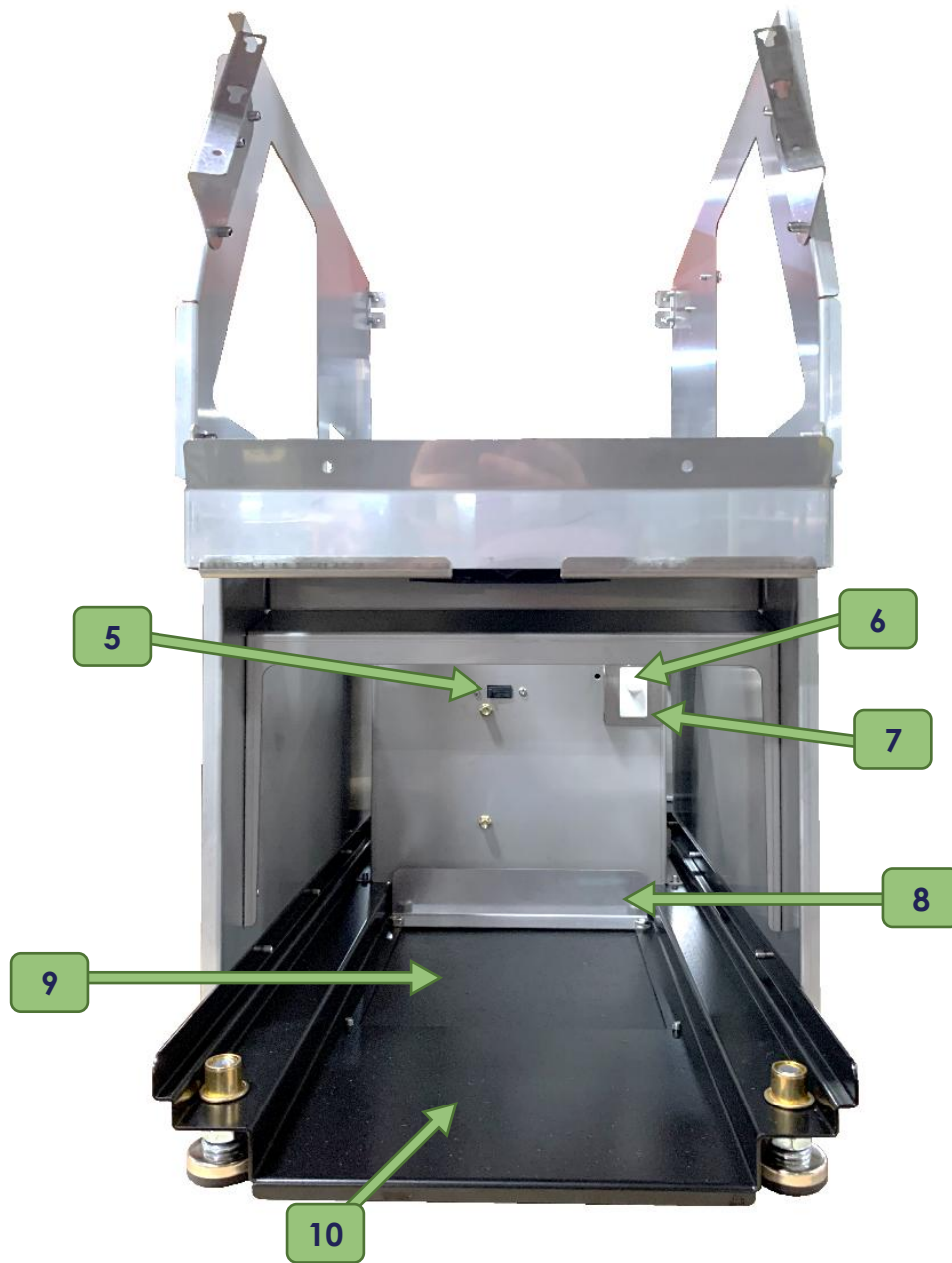

5	780780	USB CABLE ASSEMBLY (FRESH CUP TOUCH ONLY)	1 EA
6	103416	WASTE BIN SENSOR SWITCH	1 EA
7	780110	WASTE BIN SENSOR SWITCH BRACKET	1 EA
8	780475	MAGNET STOP BRACKET	1 EA
9	780307-B	REMOVABLE PLATE FOR PASS THROUGH	1 EA
10	780441-BPC	BASE PANEL	1 EA

WASTE BIN AND DRIP TRAY ASSEMBLY PN 782179

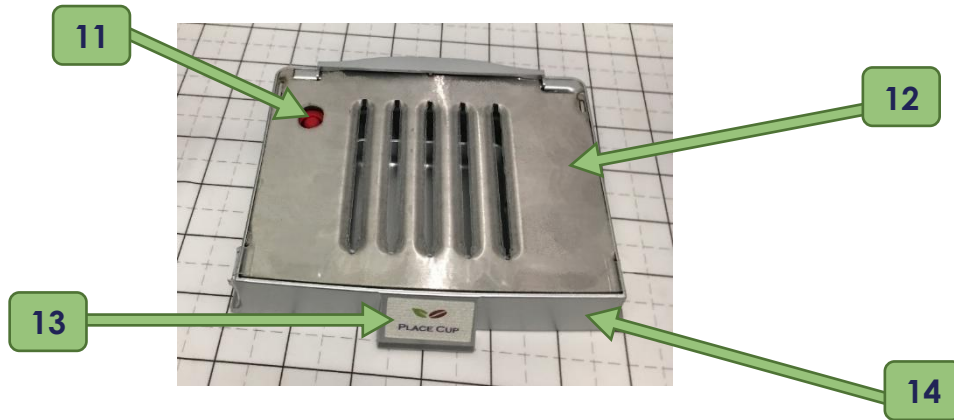

	782169	DRIP TRAY ASSEMBLY	1 EA
11	782180	LIQUID LEVEL INDICATOR (RED)	1 EA
12	782157	DRIP TRAY GRID	1 EA
13	782175	PLACE CUP LABEL	1 EA
14	782161-SV	PLASTIC SILVER DRIP TRAY	1 EA

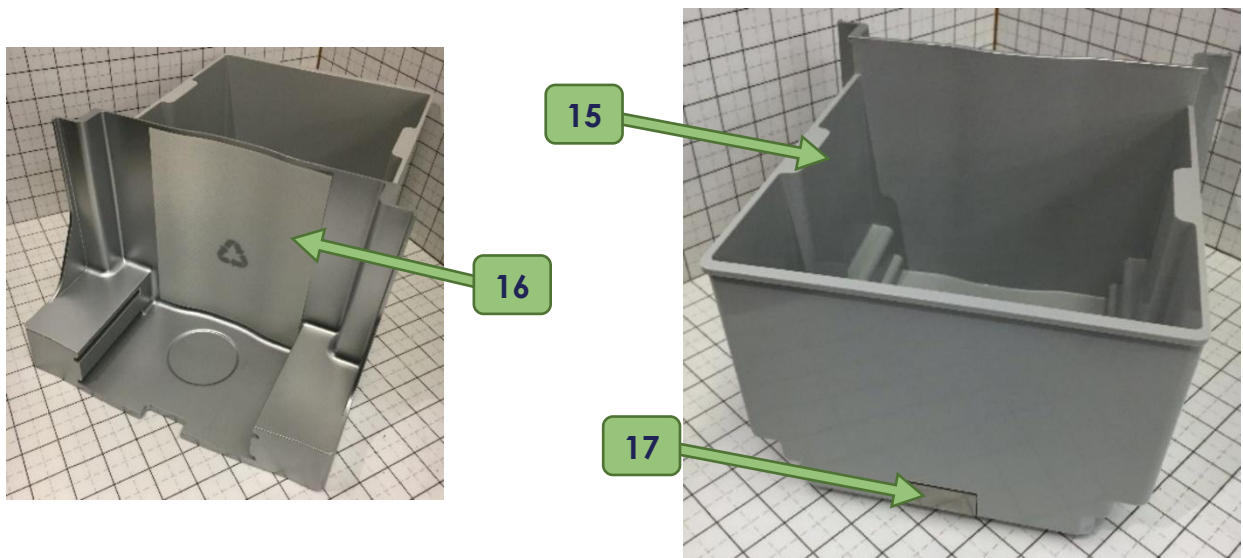

	782170	WASTE BIN ASSEMBLY	1 EA
15	782162-SV	WASTE BIN	1 EA
16	782174	WASTE BIN LABEL	1 EA
17	782160	MAGNET COVER BRACKET	1 EA
N/S	121301	WASTE BIN MAGNET	1 EA

For complete pass through waste bin assembly, order PN 782183.

DISPENSE AREA

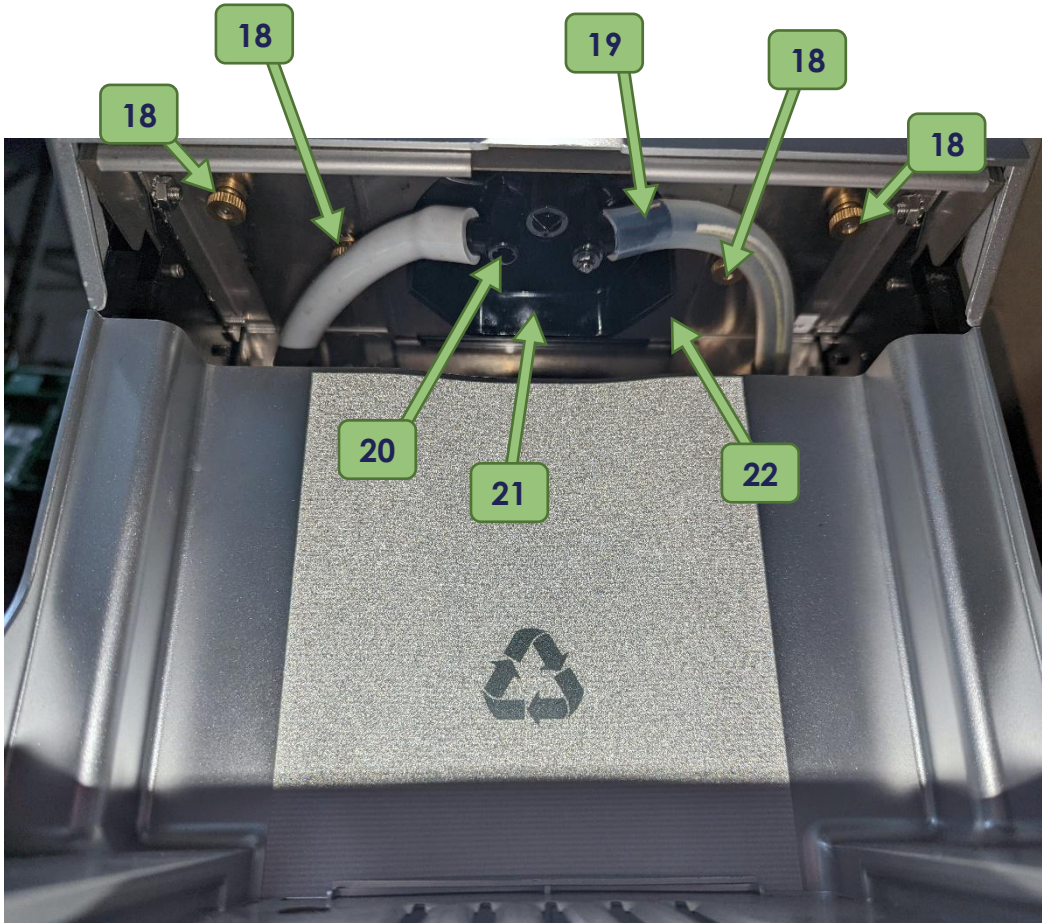

18	700021	BRASS KNURLED NUT, 8-32	4 EA
19	780357	BLUE LED WITH HARNESS	1 EA
20	767254	PRODUCT NOZZLE	1 EA
21	780592	FUNNEL ASSEMBLY WITH O-RING	1 EA
22	780041	FUNNEL RETAINER	1 EA

WATER INLET AND STRAINER ASSEMBLIES

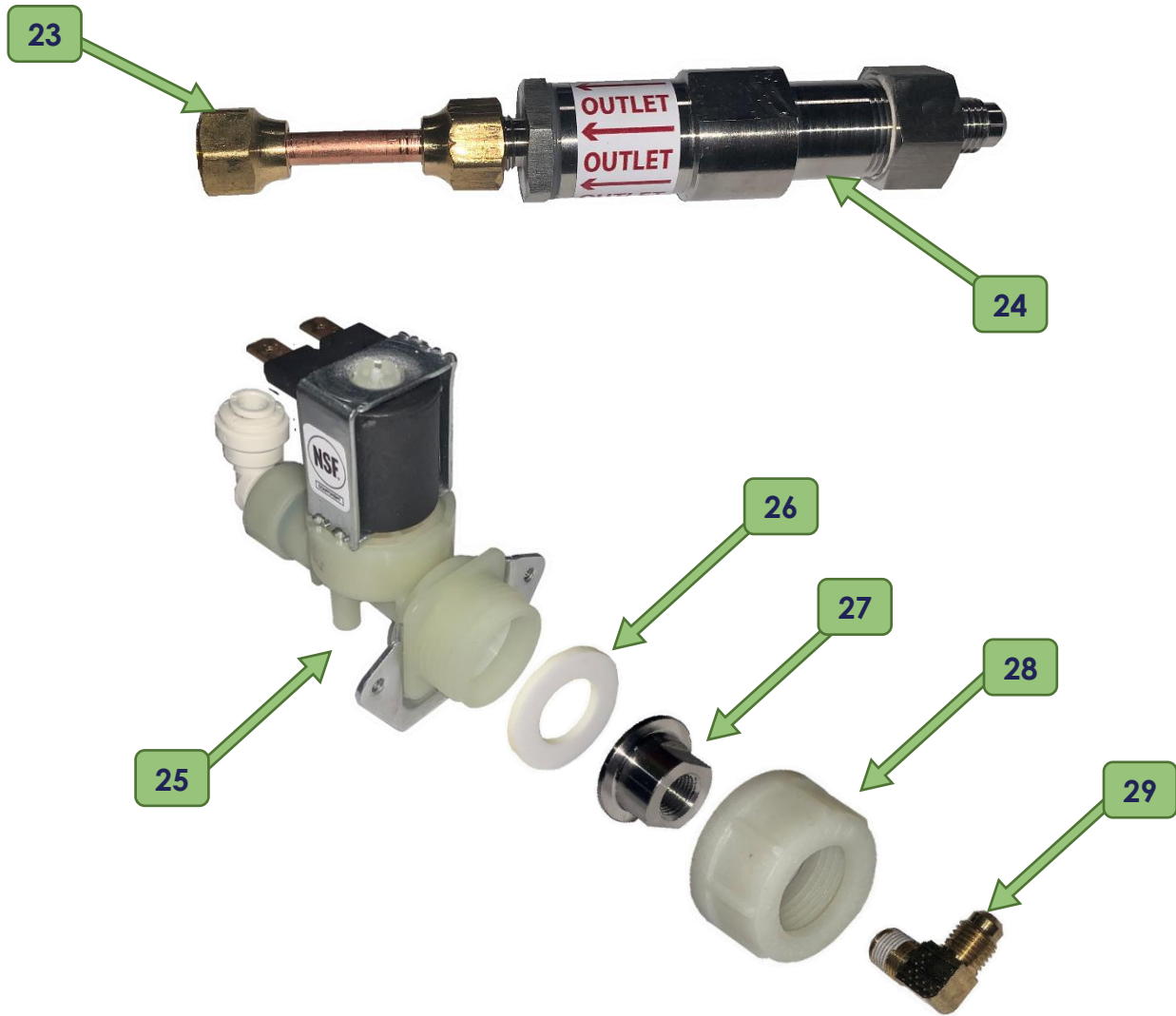

23	704209	COPPER TUBING ASSEMBLY	1 EA
24	202103	STRAINER ASSEMBLY	1 EA
25	780381	SOLENOID VALVE, 0.343 RESTRICTOR (WITH NUT & GASKET)	1 EA
26	111178	GASKET	1 EA
27	101377	SOLENOID FITTING	1 EA
28	111177	PASTIC NUT	1 EA
29	100177	ELBOW	1 EA

ASSEMBLY PN 780365		ASSEMBLY PN 202144		ASSEMBLY PN 111775	
29	ELBOW	29	ELBOW	29	ELBOW
26	FITTING	26	FITTING	26	FITTING
25	VALVE WITH NUT & GASKET	27	GASKET	27	GASKET
		28	PLASTIC NUT	28	PLASTIC NUT
		24	STRAINER ASSEMBLY		
		23	COPPER TUBING ASSEMBLY		

INLET TUBE

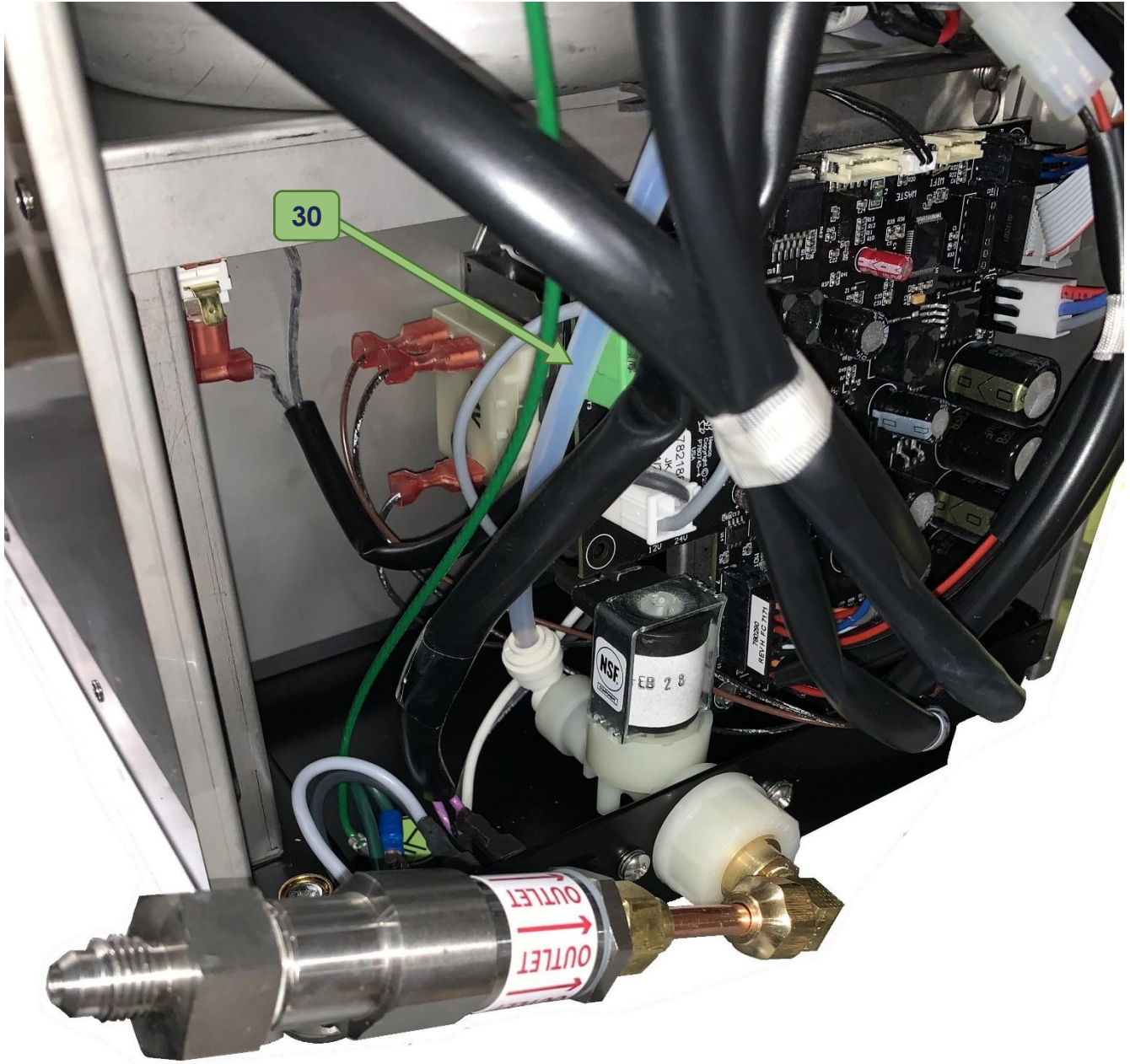

30	780300	INLET TUBE, 19" TEFLON	1 EA
----	--------	------------------------	------

FRESH CUP 4 FRONT PANEL



	780644	DOOR AND FACEPLATE ASSEMBLY	1 EA
N/S	780601	DISPLAY BOARD	1 EA
31	780633	7 BUTTON FRONT PANEL LABEL FOR MILD MED BOLD BREWS	1 EA
32	780604-SV	FRONT CABINET	1 EA
33	780603-SV	BREW MECH DOOR	1 EA
34	780605	DISPLAY BOARD BRACKET	1 EA
35	780681	LABEL,FK3,WARNING: DO NOT CLOSE	1 EA
36	780635	RIGHT SPRING BRACKET	1 EA
37	780628	LEFT SPRING BRACKET	1 EA
38	780199	SPRING	2 EA

To order front panel without display board, order PN 780678

FRESH CUP TOUCH FRONT PANEL

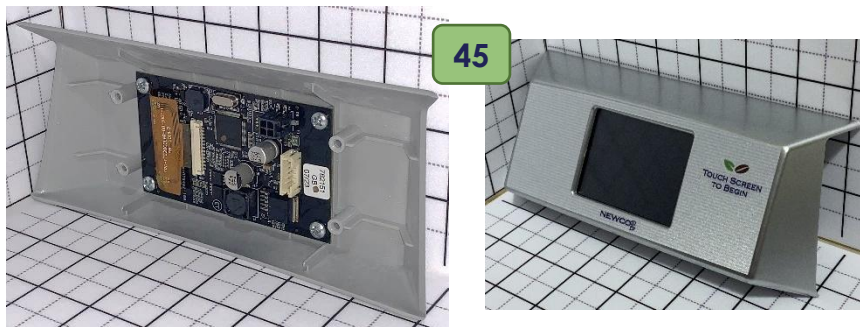
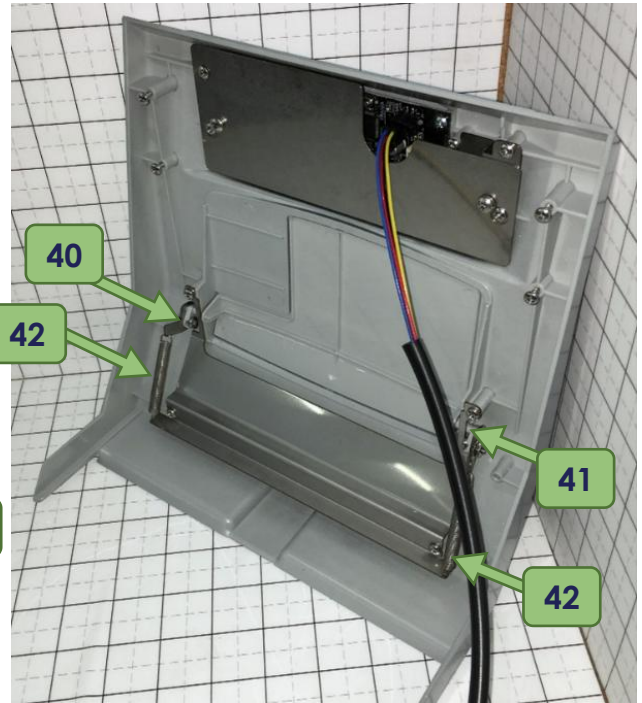

LABEL, DOOR WARNING
PN: 401741

	780750	DOOR AND FACEPATE ASSEMBLY	1 EA
39	782173	FRONT PANEL TOUCHSCREEN LABEL	1 EA
40	780635	RIGHT PIVOT BRACKET FOR SPRING	1 EA
41	780628	LEFT PIVOT BRACKET FOR SPRING	1 EA
42	780199	SPRING	2 EA
43	780756-SV	SILVER PLASTIC FRONT PANEL CABINET	1 EA
44	780603-SV	BREW MECH DOOR	1 EA
45	782199-10	DISPLAY BOARD AND TOUCHSCREEN ASSEMBLY	1 EA
N/S	780753	TOUCH SCREEN RETAINER	2 EA

DRAINING THE HOT WATER TANK

Tank holds approximately 1 US gallon.

Caution- Unless the tank is left to cool the water is extremely hot and can cause harmful burns. Do not store in freezing conditions as residual water may remain in the machine.

METHOD 1

TO DRAIN

1. Unplug machine and remove waste bin. Allow machine to cool before proceeding.
2. About halfway back, and on the left side, about halfway up, locate the tube clip. Follow the tube up to locate the drain tube bracket. See Image 1.
3. Push the tubing up to release it from the bracket. You may need to follow the bracket to the right and push up on the tube from the right side to fully release the drain tube.
4. Pull the tubing down and out to the front of the machine.
5. Remove the tube plug using pliers, then aim the end of the tube to where you are draining the water. Push up on tube clip to open tube. See Image 2.

TO REPLACE

1. Once the tank is fully drained, tighten the tube clip and insert the drain plug.
2. Feed the tube back up into machine, starting from right side of the tubing.
3. Locate the tubing bracket and line tube up with bracket.
4. Using your fingertips, press on the tube and roll it down into the bracket until secure.
5. Ensure tube clip is tucked away on the left side of the tank plate so that it does not interfere with brewing mechanism.

METHOD 2

TO DRAIN

1. Unplug machine and remove waste bin. Allow machine to cool before proceeding.
2. Remove top cover of machine. See page 4.
3. Locate drain tube and drain tube bracket. See Image 1.
4. Starting on the left side, pull drain tube up out of the bracket. Once free, feed the drain tube down and out to the front of the machine.
5. Remove the tube plug using pliers, then aim the end of the tube to where you are draining the water. Push up on tube clip to open tube. See Image 2.

TO REPLACE

1. Once the tank is fully drained, tighten the tube clip and insert the drain plug.
2. Feed the tube back up to top of machine, starting from right side of the tubing.
3. Line the tubing up with the drain tube bracket, then, starting on the right side, push and roll down to secure tubing into bracket.
4. Replace the top cover of machine.

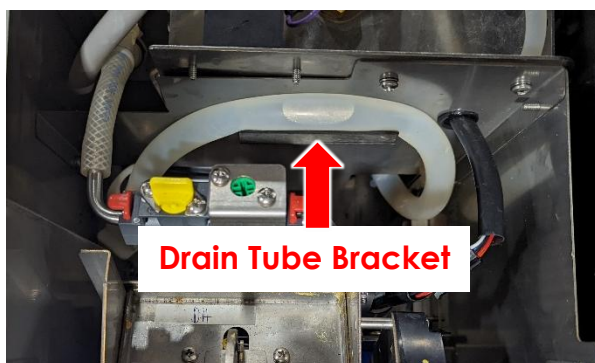

Image 1

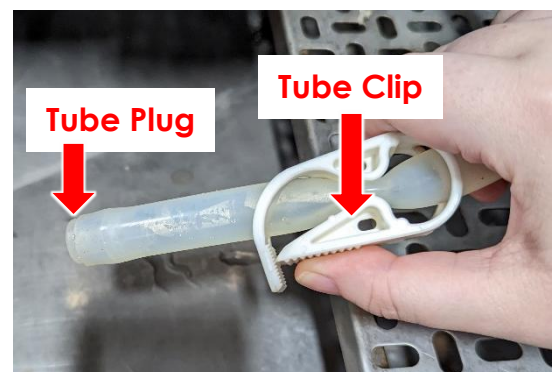

Image 2

TANK REMOVAL

Before beginning any servicing on the brewer, ensure power is turned off and disconnected. Once brewer is cool, see page 14 for draining the hot water tank. After hot water tank has been drained, servicing may begin.

1. Remove top cover, back panel, and left side panel. See page 4.

2. Loosen 2 screws (PN 105043) then push down to release shipping bracket

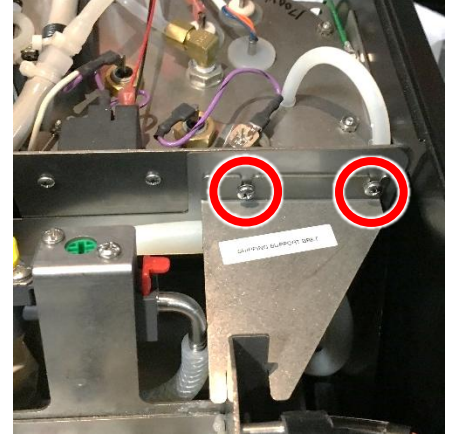

3. Remove 2 nuts – PN 107069 near back of machine, and PN 107240 near front of machine.

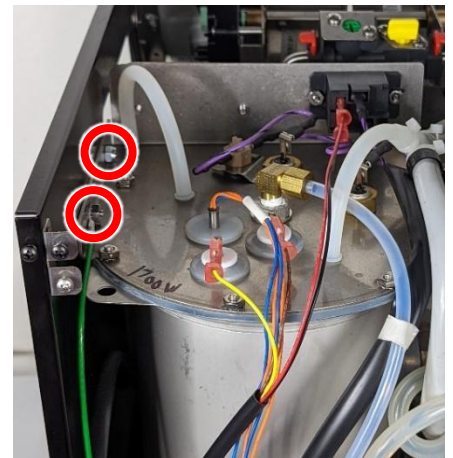

4. Some machines may need to remove a nut PN 100061 on the vibration isolation mount

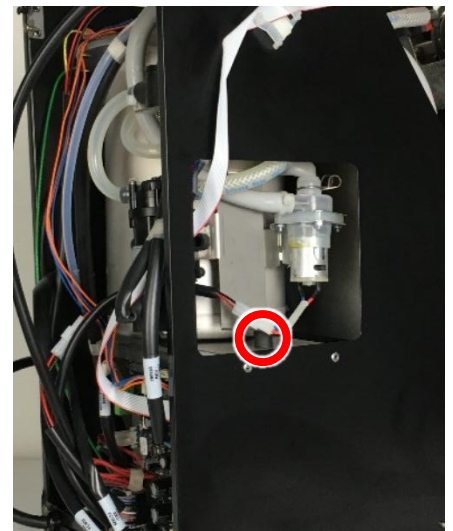

TANK ASSEMBLY PN 780619

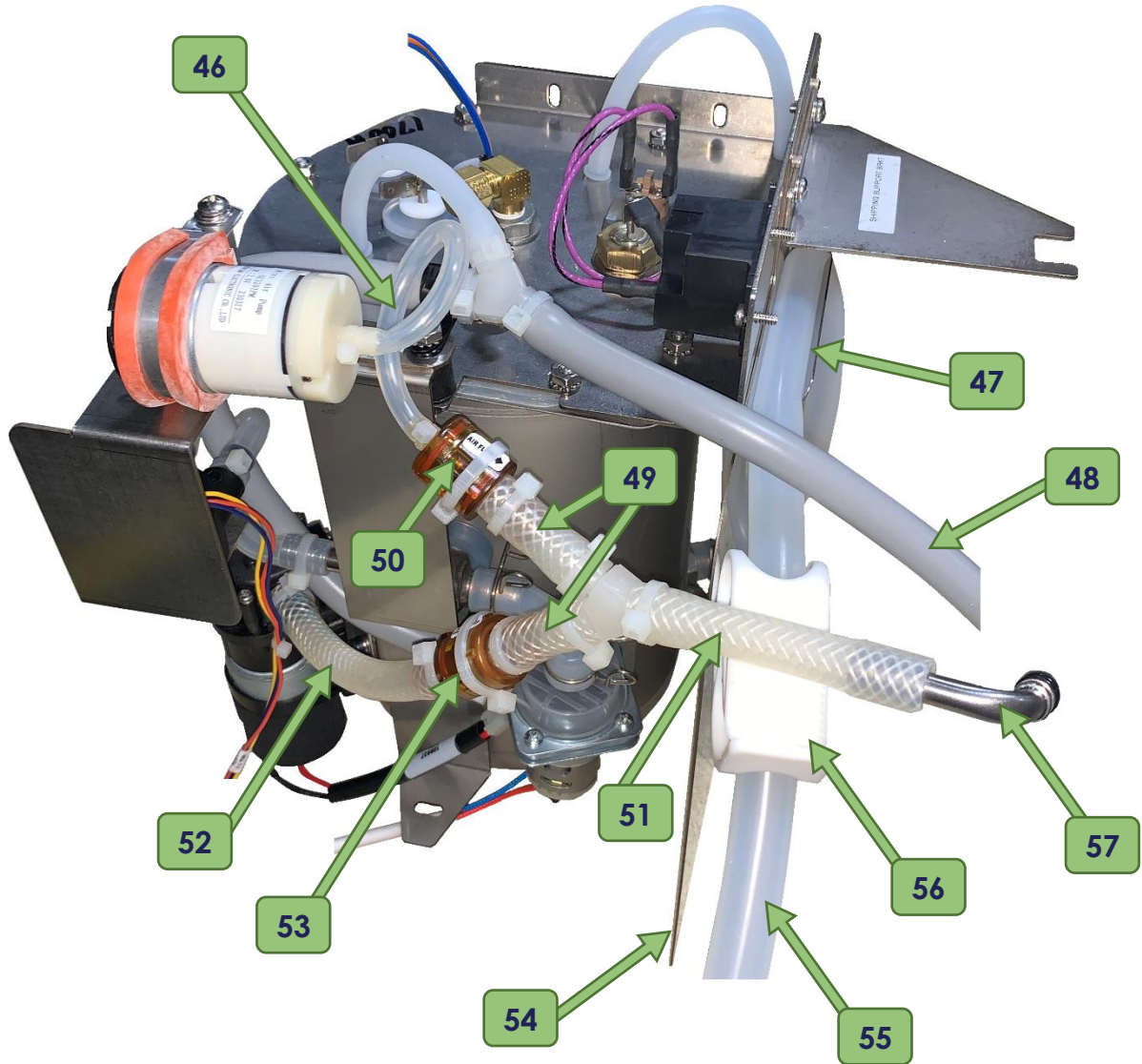

46	780346	SILICONE TUBING 5"	1 EA
47	780350	DRAIN HOSE BRACKET	1 EA
48	780341	GRAY SILICONE TUBING, 11"	1 EA
49	706331	REINFORCED SILICONE TUBING 1.5"	2 EA
50	202165	CHECK VALVE ASSEMBLY, 1/4 X 1/8	1 EA
51	780344	REINFORCED SILICONE TUBING 3"	1 EA
52	780636	REINFORCED SILICONE TUBING 4.5"	1 EA
53	202178	CHECK VALVE ASSEMBLY, 1/4 X 1/4	1 EA
54	780333	TANK PLATE	1 EA
55	107341	SILICONE TUBING 20"	1 EA
56	701646	LARGE PLASTIC HOSE CLAMP	1 EA
57	780305	ELBOW WITH O RING	1 EA
N/S	111635	HOSE CLAMP, 0.574" ID	2 EA

TANK ASSEMBLY PN 780619 CONT.

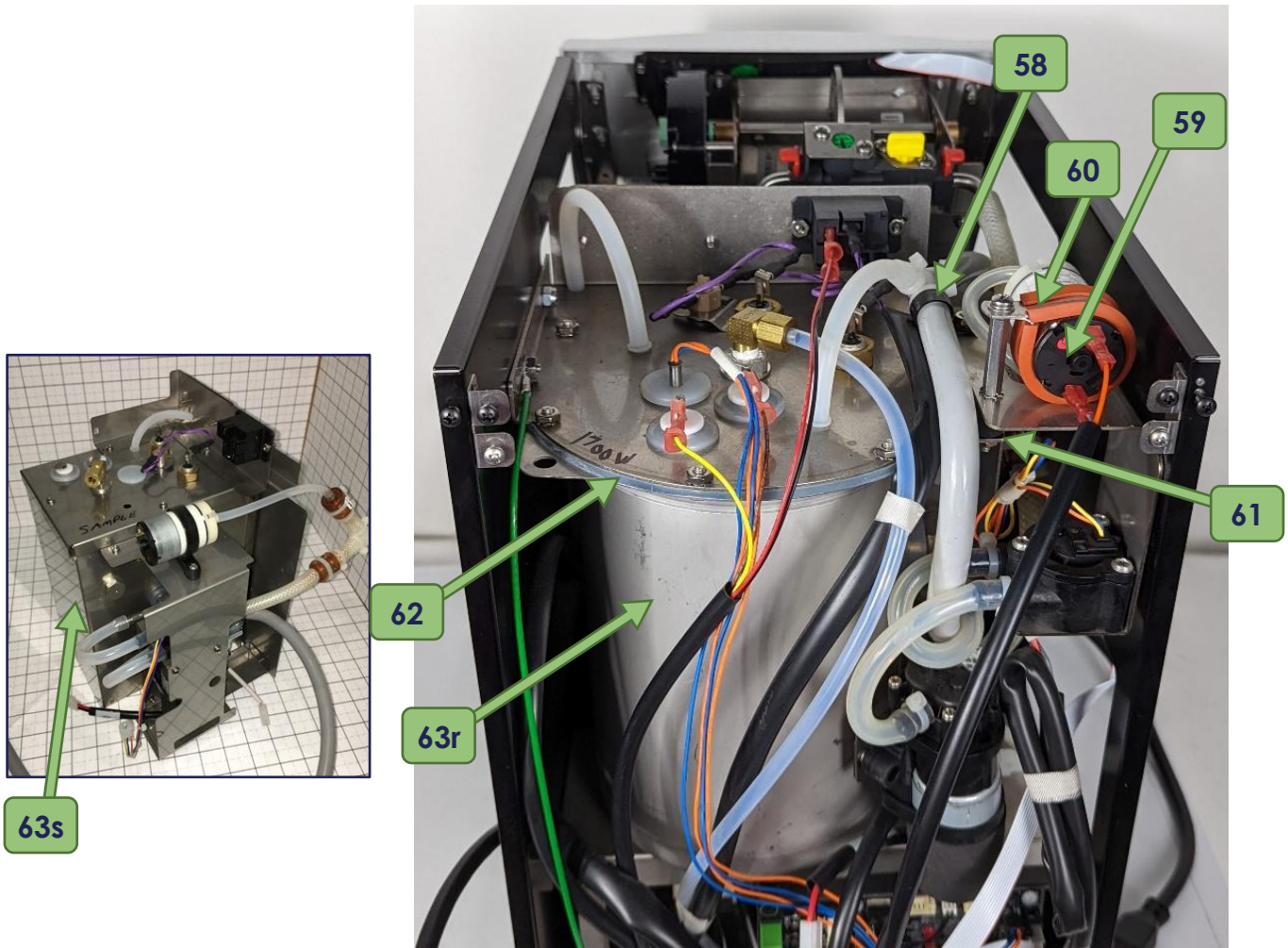

58	780323	NYLON LOOP CLAMP	1 EA
59	773056	AIR PUMP	1 EA
60	780749	LOOP CLAMP FOR VIBRATION DAMPENING	1 EA
61	706346	VIBRATION ISOLATION MOUNT (1 OF 2)	2 EA
62	704221	TANK GASKET (ROUND)	1 EA
N/S	*119882	*TANK GASKET (SQUARE)	1 EA
63r	780253	TANK ONLY (ROUND)	1 EA
63s	*783372	*TANK ONLY (SQUARE)	1 EA
N/S	100030	TIN PLATED GASKET	2 EA
N/S	100408	BARBED TUBING PLUG	1 EA
N/S	102835	TIN PLATED OUTLET BULKHEAD	1 EA
N/S	131133	VALVE GROMMET	1 EA

* = Used with tank alternative, square tank assembly PN 783371

PUMP AND BRACKET ACCESS

Before beginning any servicing on the brewer, ensure power is turned off and disconnected. Once brewer is cool, see page 14 for draining the hot water tank. After hot water tank has been drained, servicing may begin. See page 4 for panel removal instructions.

TO ACCESS THE PUMP AND BRACKET ASSEMBLY

Remove the left side panel. See page 4 for instructions.



TO REMOVE THE PUMP AND BRACKET ASSEMBLY FROM THE TANK

To remove tank assembly from the machine, see page 15.

1. Once tank assembly is removed from the machine, remove two nuts and washers, circled.
2. Disconnect grey silicone tubing from Y Fitting PN 767281 and remove loop clamp.
3. Pull the stainless steel T fitting from grommet PN 131133.
4. Disconnect silicone tubing from the stainless steel T fitting and the gear pump.

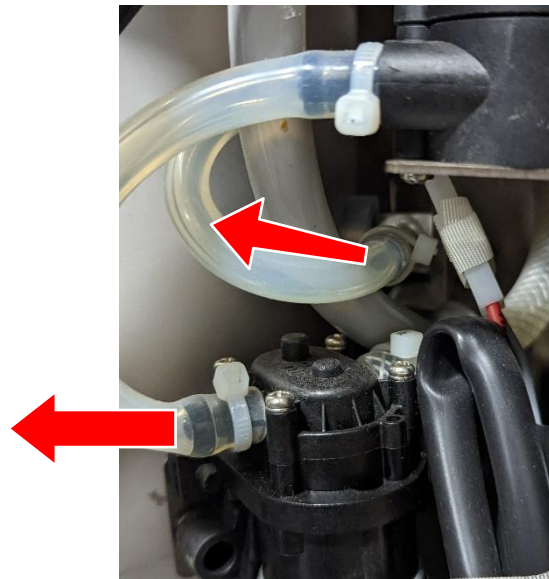
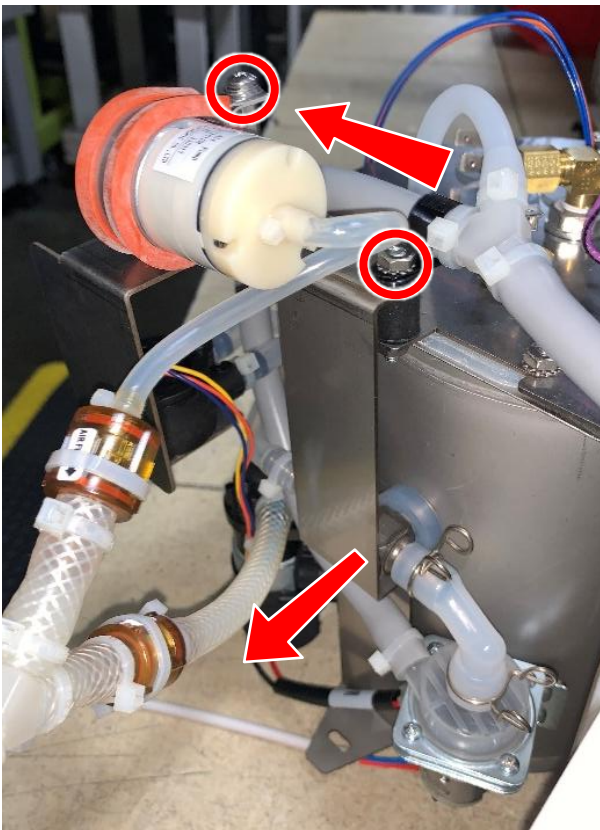

WHEN REASSEMBLING:

Be sure to loop silicone tubing between the air pump and the check valve, any "kinks" in the tubing may impact performance.

TANK ASSEMBLY PN 780619 CONT.

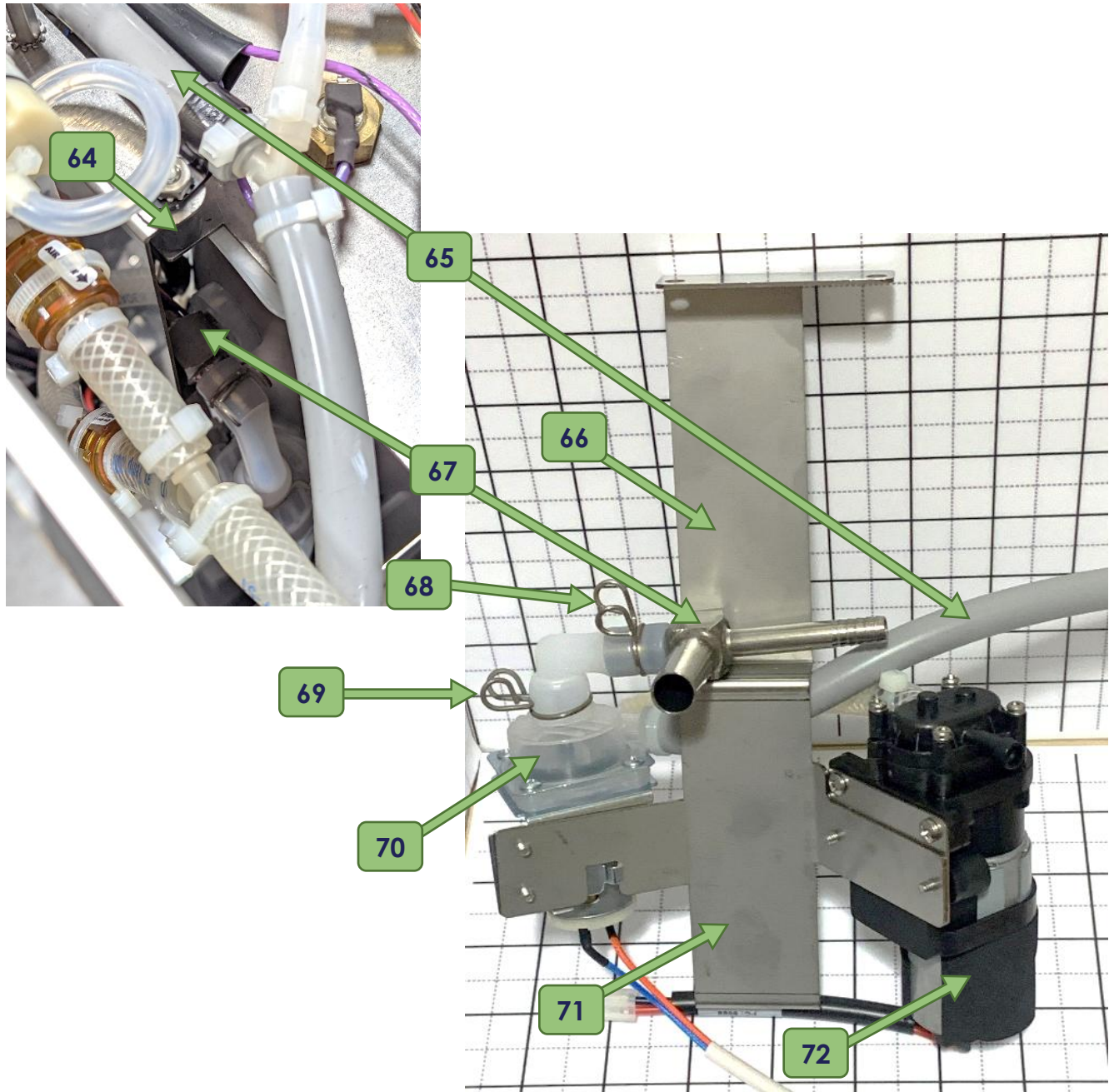

	780617	PUMP & BRACKET ASSEMBLY	
66	780778	MOUNTING BRACKET ADAPTOR PLATE	1 EA
69	111635	HOSE CLAMP, 0.574" ID	1 EA
70	781772	WATER PUMP ASSEMBLY	1 EA
71	780777	PUMP MOUNTING BRACKET	1 EA
72	109937	GEAR PUMP ASSEMBLY	1 EA

For use with square tank, order bracket assembly PN 783380.

64	706346	VIBRATION ISOLATION MOUNT (2 OF 2)	2 EA
65	780297	GRAY SILICONE TUBING, 17.5"	1 EA
67	780336	STAINLESS STEEL T FITTING	1 EA
68	111634	HOSE CLAMP, 0.459" ID	1 EA

TANK LID ASSEMBLY PN 780647

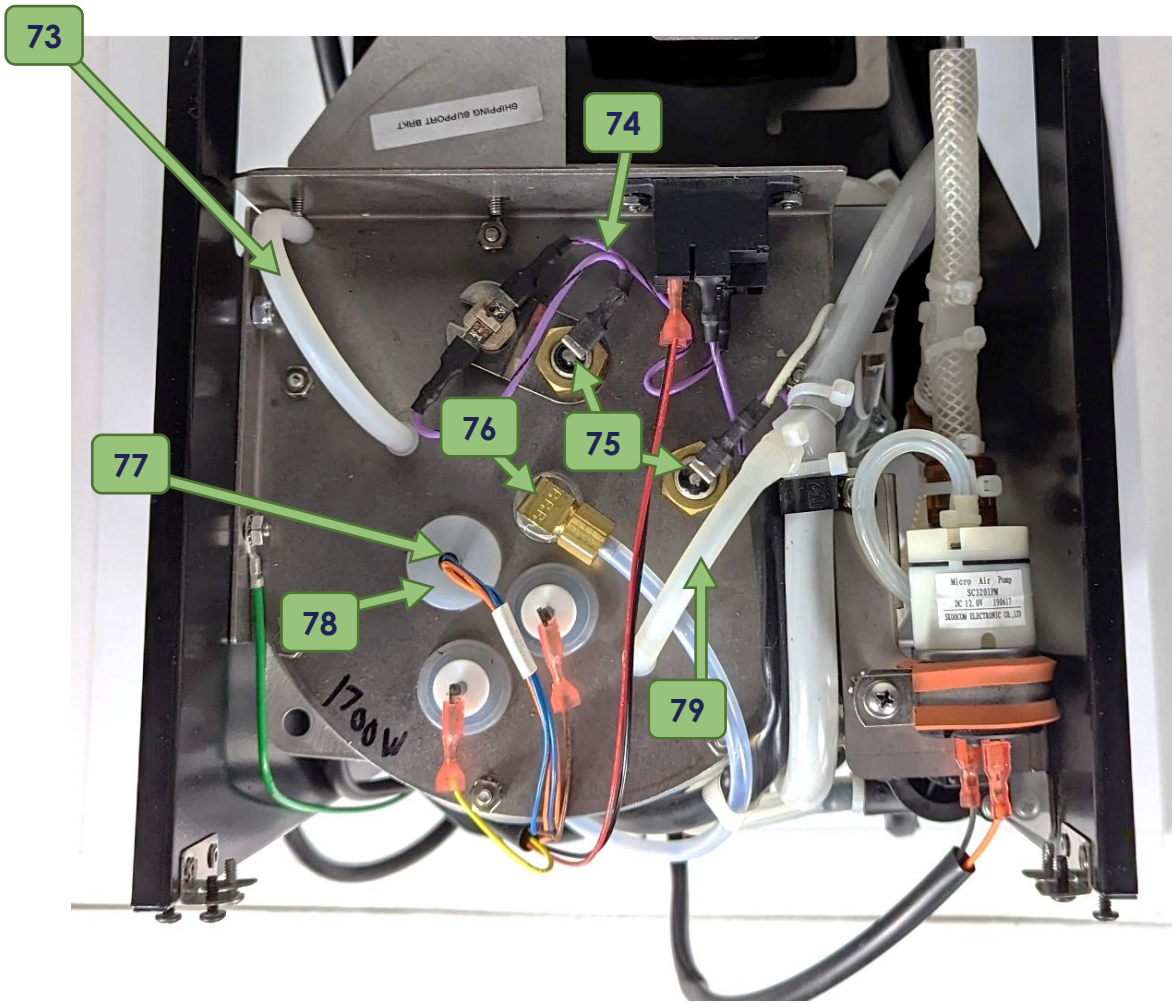

73	780347	SILICONE VENT TUBE	1 EA
74	700130	14 GAUGE VIOLET AND BLACK WIRE	2 EA
75	704166-10	TANK HEATING ELEMENT	1 EA
76	100149	STEEL AND NICKEL ELBOW	1 EA
77	151677	DUAL TEMPERATURE PROBE WITH WIRING HARNESS	1 EA
78	500038	SILICONE GROMMET (NO SLIT)	1 EA
79	780348	SILICONE OVERFLOW TUBE	1 EA
N/S	100030	BRASS GASKET	2 EA
N/S	100409	TIN PLATED GASKET	2 EA
N/S	101720	TIN PLATED FEMALE CONNECTOR	1 EA
N/S	780274	STAINLESS STEEL INLET TUBE	1 EA

TANK LID ASSEMBLY PN 780647 CONT.

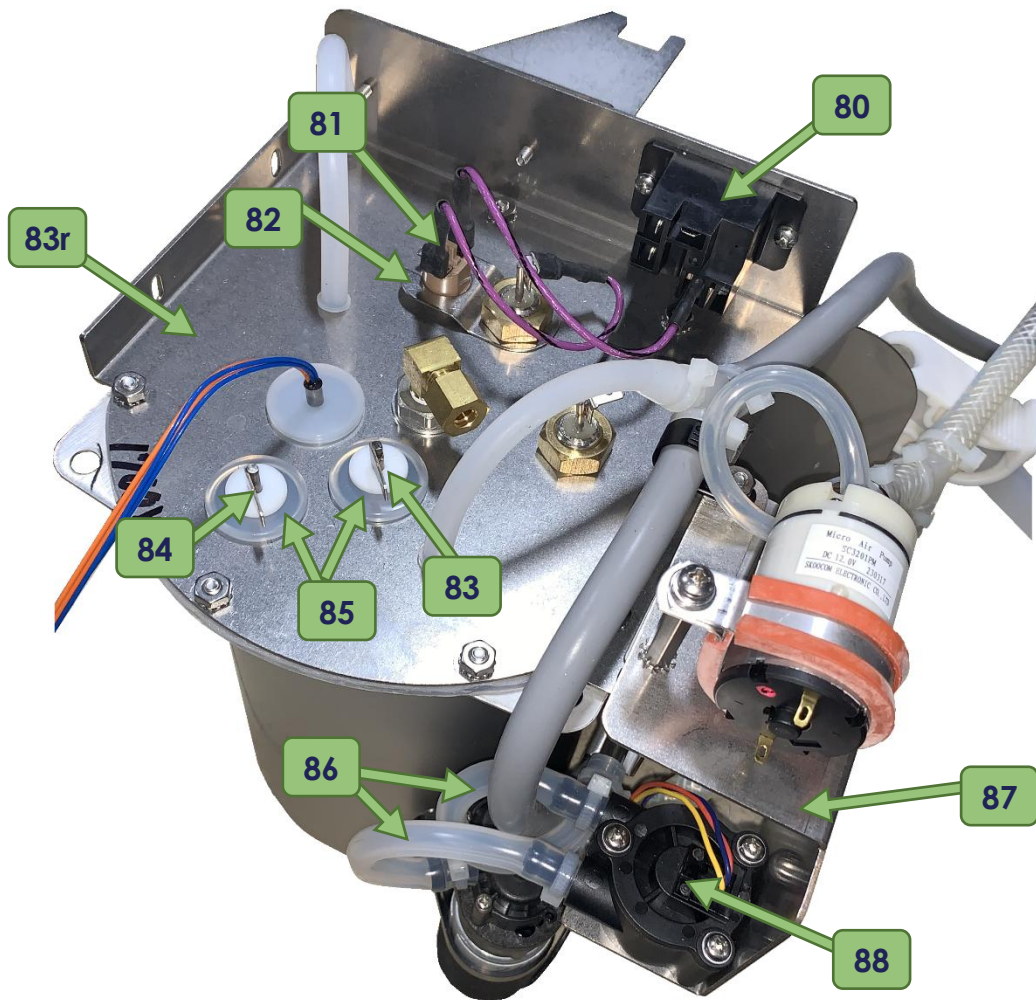

80	110958	RELAY	1 EA
81	111593	MANUAL THERMISTOR WITH VERTICAL TABS	1 EA
82	100269	HI LIMIT THERMOSTAT BRACKET	1 EA
83r	780229	TANK LID (ROUND)	1 EA
N/S	*783377	*TANK LID (SQUARE)	1 EA
84	500398	PROBE AND BUSHING ASSEMBLY	2 EA
85	500350	PROBE BUSHING GROMMET	2 EA
86	780414	SILICONE TUBING FLOW METER CONNECTION	2 EA
87	780415	FLOW METER MOUNTING BRACKET	1 EA
88	780684-10	FLOW METER	1 EA
N/S	100166	BRASS COMPRESSION SLEEVE	1 EA
N/S	110944	BRASS SLEEVE	1 EA

* = Used with tank alternative, square tank assembly PN 783371

UNIVERSAL 2 BREW MECH PN 780585

BREW MECH REMOVAL

Before beginning any servicing on the brewer, ensure power is turned off and disconnected. Once brewer is cool, see page 14 for draining the hot water tank. After hot water tank has been drained, servicing may begin. See page 4 for panel removal instructions.

Remove two brass knurled nuts (PN 700021).
Be sure you do not lose the washer.

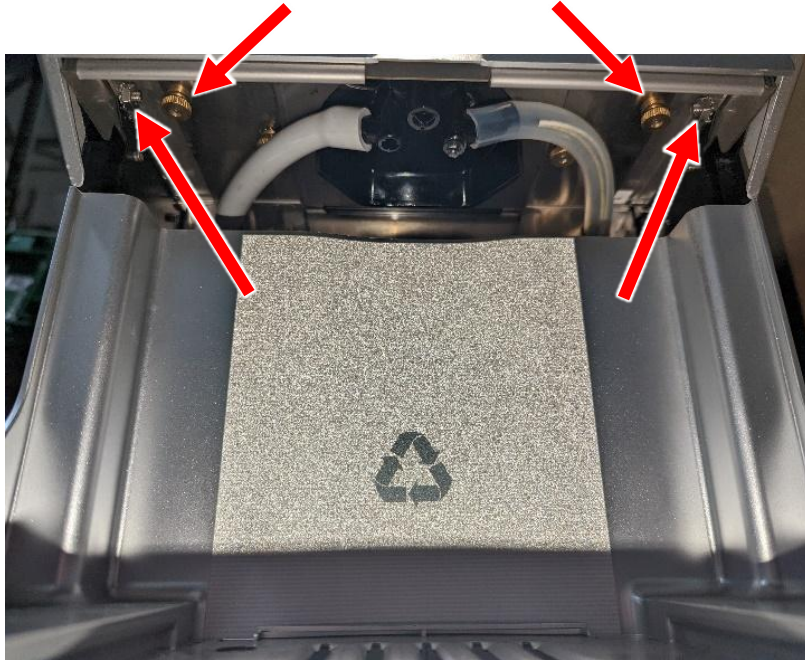

Next, disconnect the water fitting
and the harness fitting.



WITH UNIVERSAL 2 BREW MECH PN 780585

FRONT VIEW

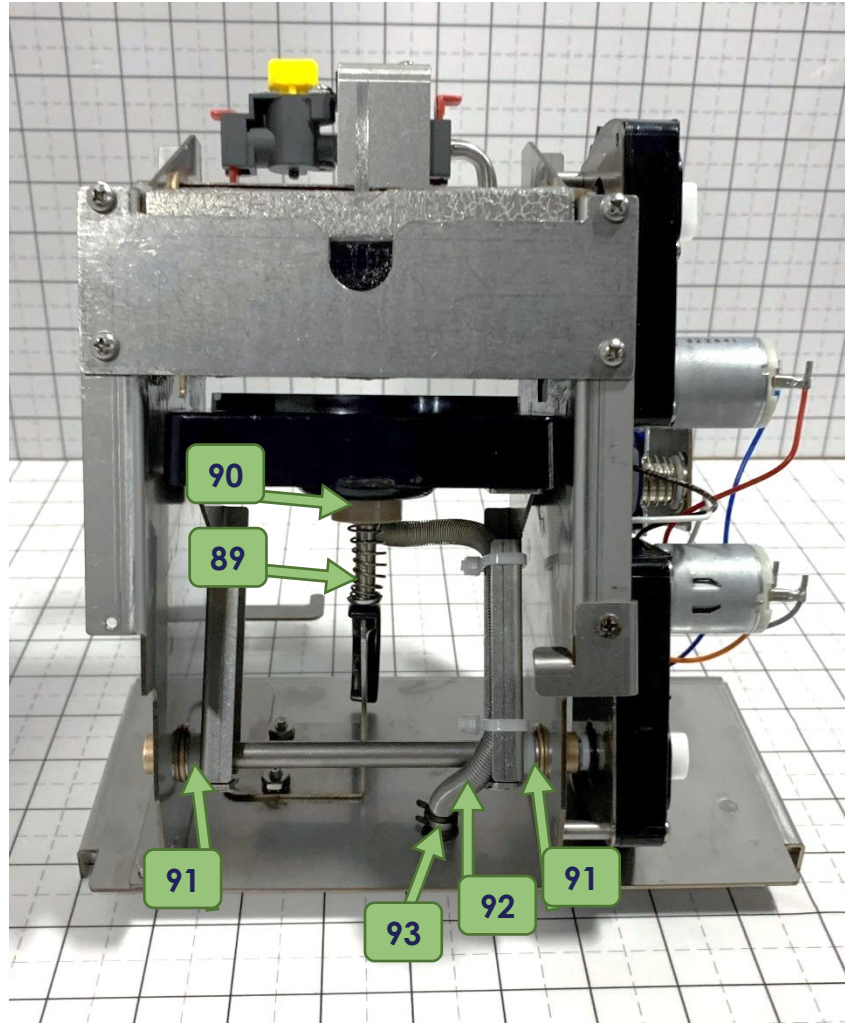

88	783370	BUSHING WITH SPRING POCKET	1 EA
89	780541	SPRING	1 EA
90	780242	NYLON SPACER	2 EA
91	780320	SILICONE BREW HOSE (WITH 780368)	1 EA
92	780368	BREW HOSE SPRING (WITH 780320)	1 EA
93	100440	HOSE CLAMP	2 EA
N/S	773246	U-CUP SEAL	1 EA
N/S	780264	O-RING	1 EA
N/S	780321	SPRAY HEAD DELIVERY TUBE FITTING	1 EA

WITH UNIVERSAL 2 BREW MECH PN 780585

SIDE VIEW

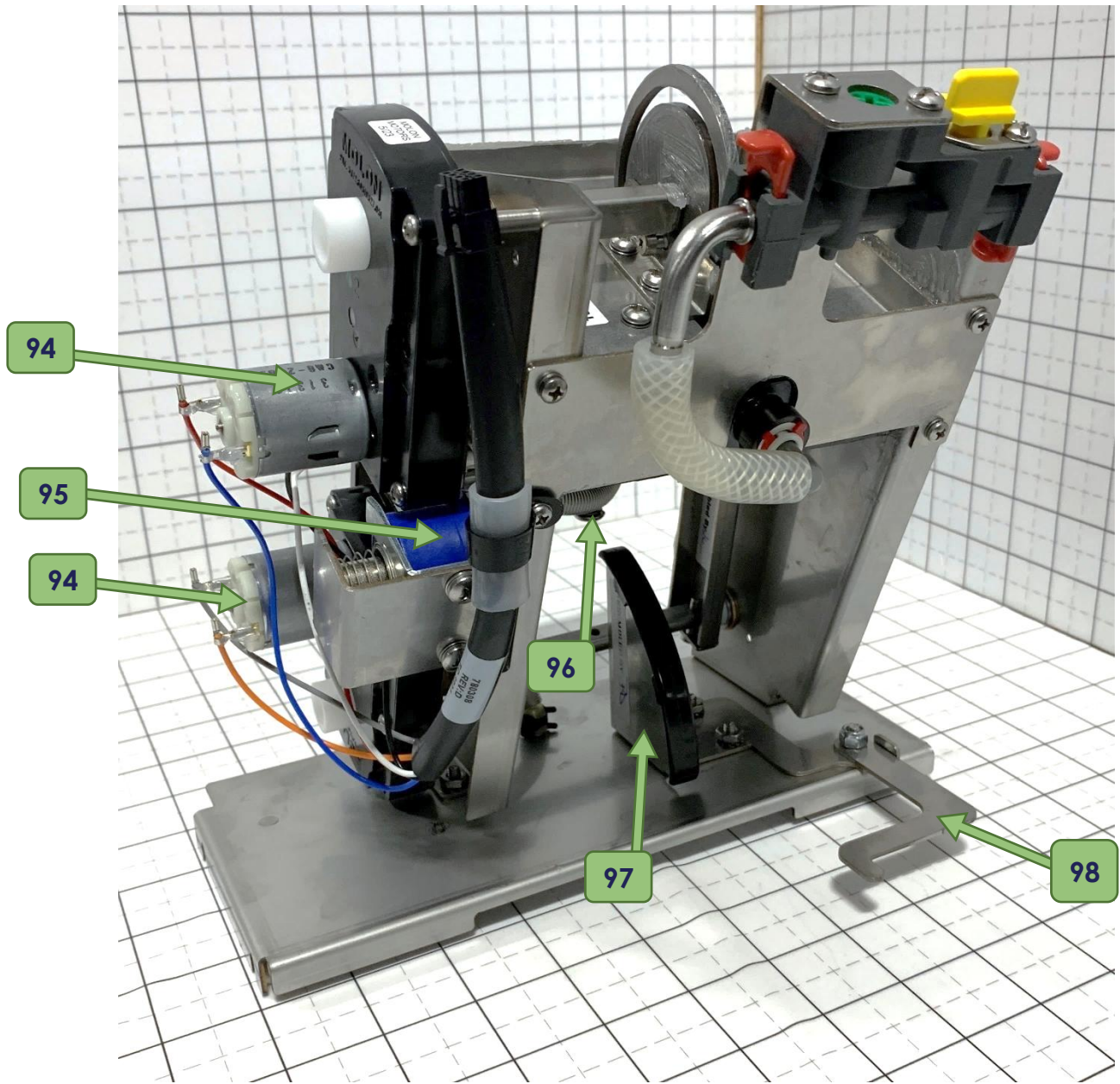

94	780230	BREW MECH MOTOR	2 EA
	780476	SOLENOID ASSEMBLY WITH PIN	1 EA
95	780231	SOLENOID	1 EA
	780537	KICKER SLOPE BRACKET ASSEMBLY	1 EA
96	780396	POD EJECTOR CAP	1 EA
97	780532	KICKER SLOPE CAM BRACKET	1 EA
98	780417	KICKER SLOPE ARM	1 EA

WITH UNIVERSAL 2 BREW MECH PN 780585

REAR VIEW

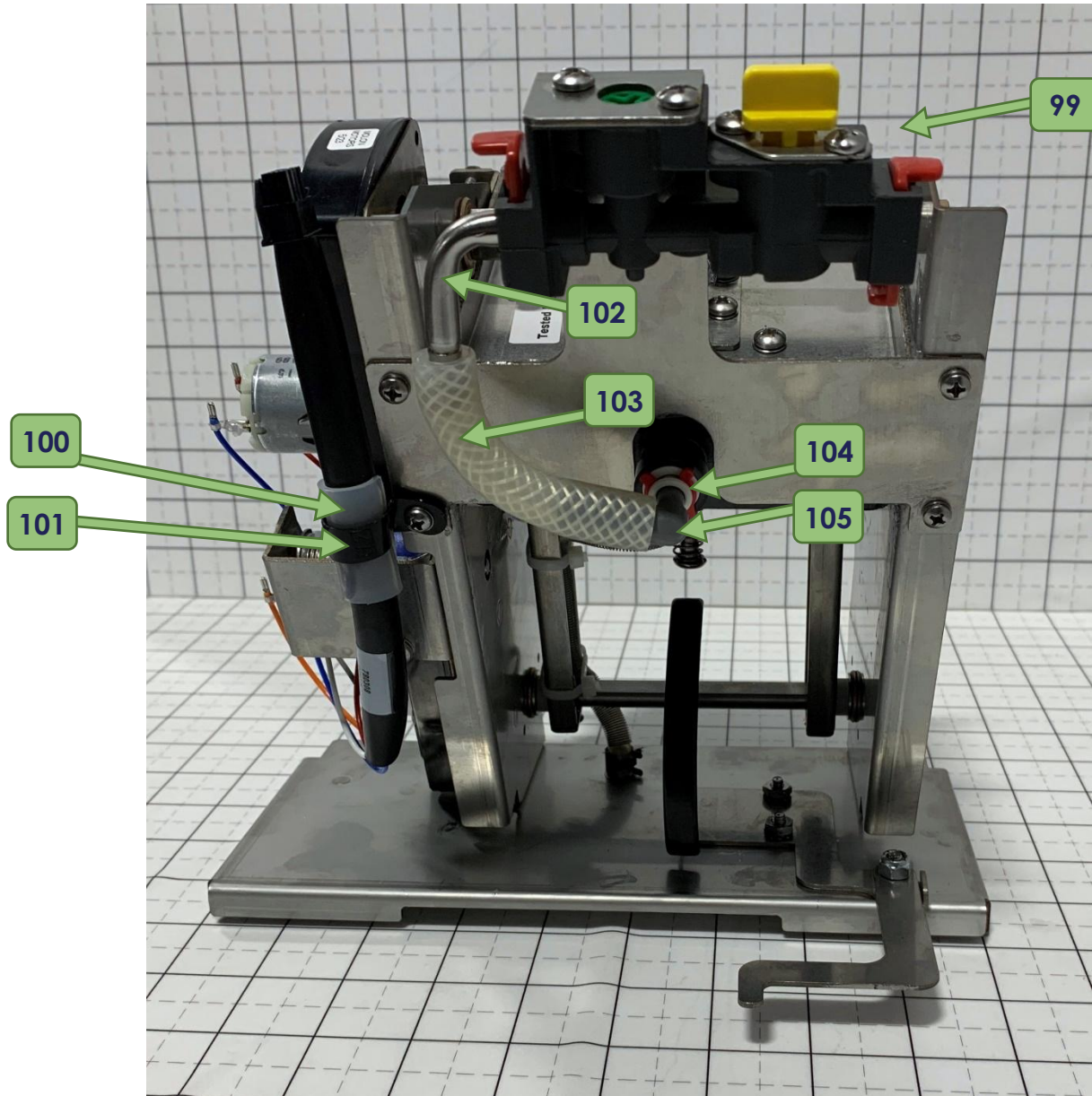

99	320043	FLOW SHUTOFF WIITH NO FITTINGS	1 EA
100	111390	SILICONE TUBING	1 EA
101	780323	NYLON LOOP CLAMP	1 EA
104	106012	RED HOSE CLIP	1 EA
105	205085	ELBOW	1 EA
N/S	780096	BREW MECH GUTTER	1 EA

	780477	FITTING ASSEMBLY WITH O-RING, 90 DEGREES	1 EA
102	780305	ELBOW WITH O-RING	1 EA
103	706349	REINFORCED SILICONE TUBING	1 EA

61MM BREW MECH PN 780622

BREW MECH REMOVAL

Before beginning any servicing on the brewer, ensure power is turned off and disconnected. Once brewer is cool, see page 14 for draining the hot water tank. After hot water tank has been drained, servicing may begin. See page 4 for panel removal instructions.

Remove two brass knurled nuts (PN 700021).
Be sure you do not lose the washer.



Next, disconnect the water fitting and the harness fitting.



WITH 61MM BREW MECH PN 780622

FRONT VIEW

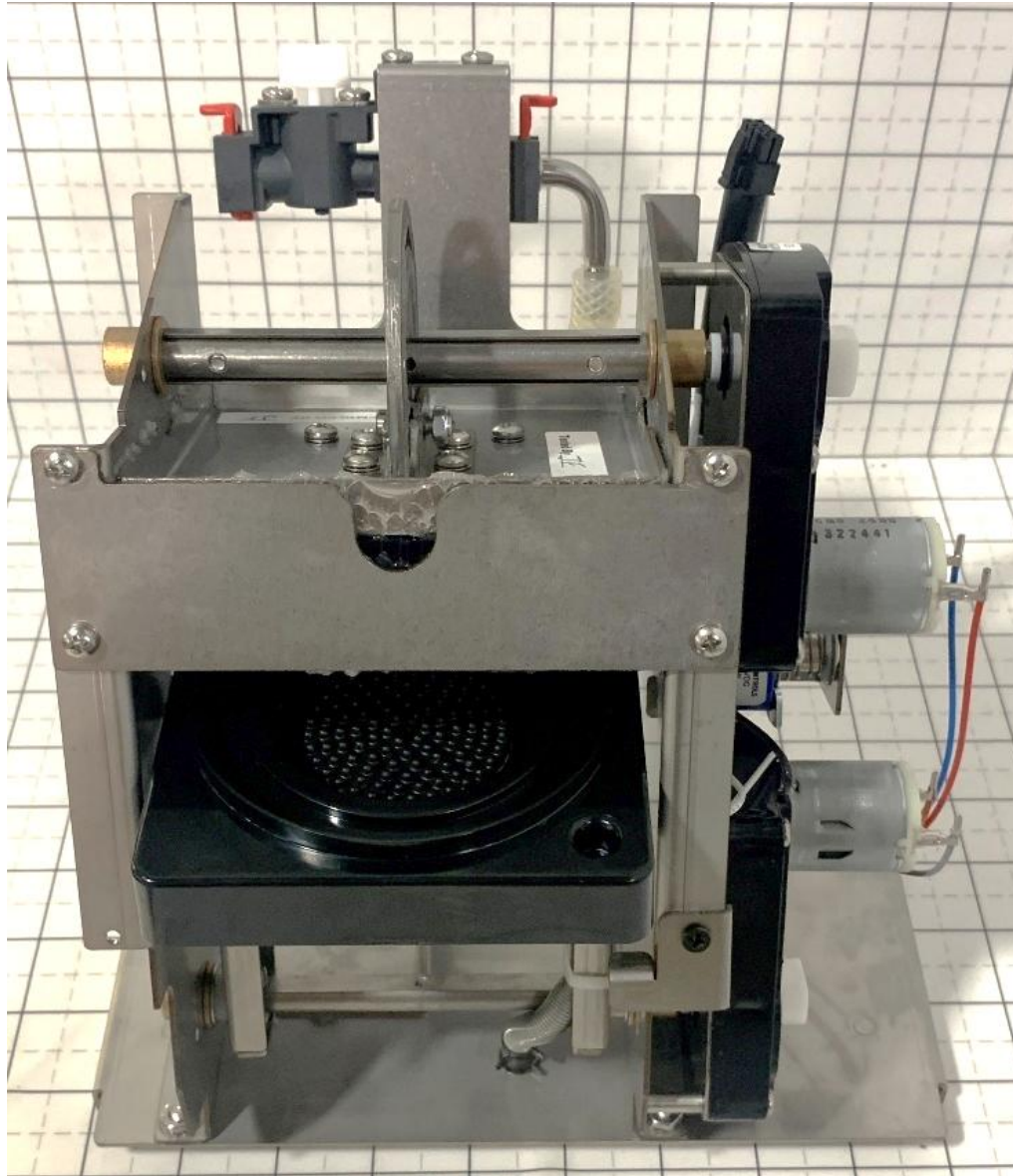

N/S	773246	U-CUP SEAL	1 EA
N/S	780264	O-RING	1 EA
N/S	780321	SPRAY HEAD DELIVERY TUBE FITTING	1 EA

ELECTRONICS ACCESS

Before beginning any servicing on the brewer, ensure power is turned off and disconnected. Once brewer is cool, see page 14 for draining the hot water tank. After hot water tank has been drained, servicing may begin. See page 4 for panel removal instructions.

TO REMOVE THE CONTROL BOARD

Remove back panel, see page 4.

Loosen but do not remove 2 screws, PN 105048, circled.

Lift and pull control board and bracket to remove from the machine. Set control board to the side.

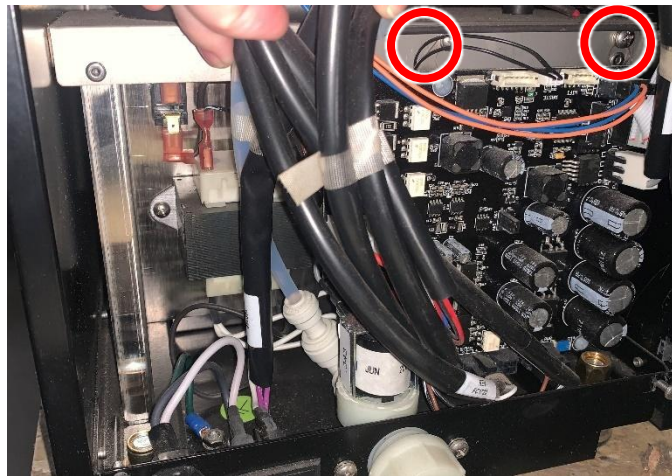

TO REMOVE THE TRANSFORMER

Transformer is mounted behind the control board. Remove two screws to release the transformer.

NOTE: Transformer may be in one of two orientations, shown below.

Screws on sides



Screws on top and bottom



TRANSFORMER AND POWER CORD

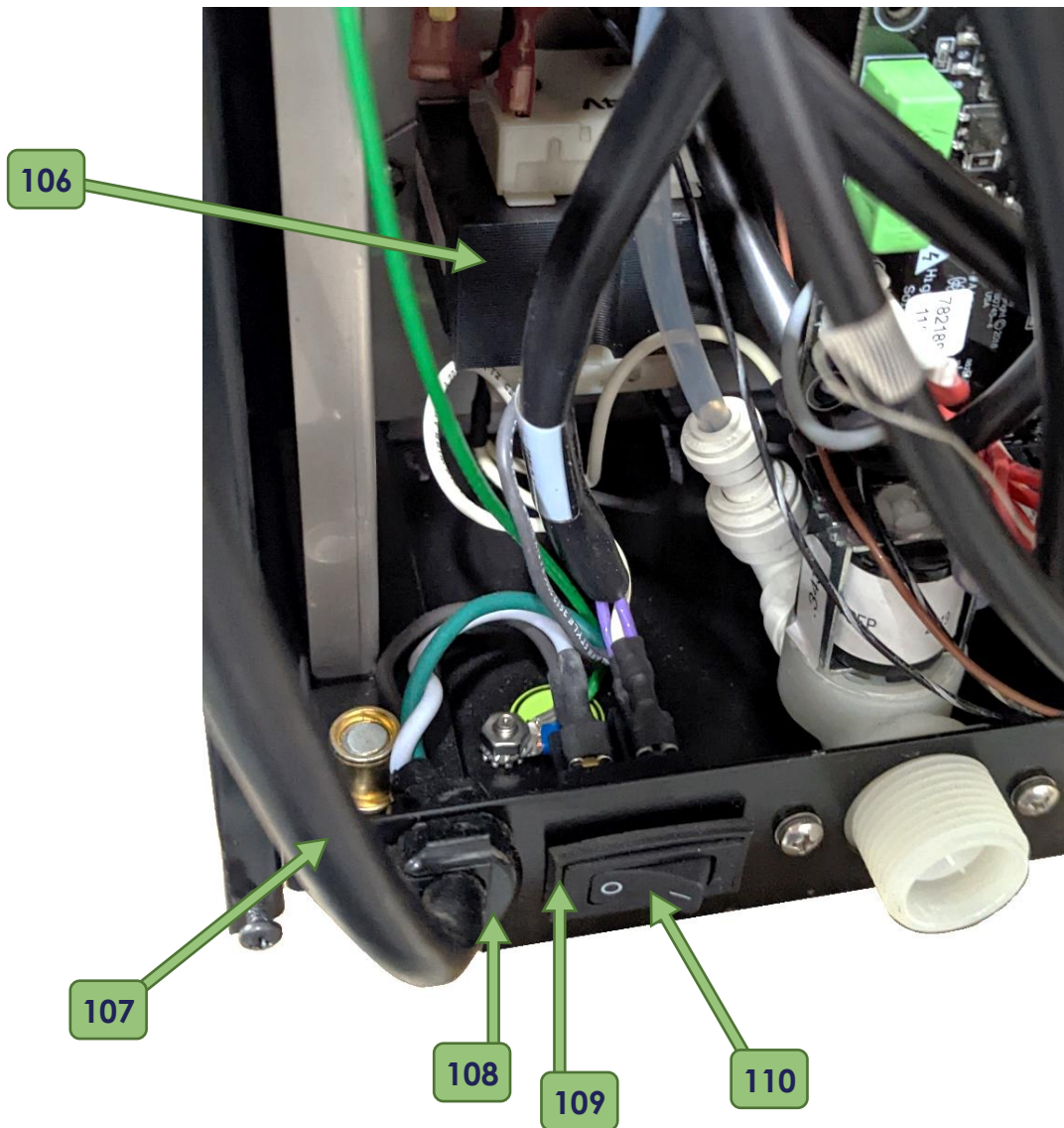

106	105115	TRANSFORMER	1 EA
107	781843	POWER CORD	1 EA
108	101035	STRAIN RELIEF GROMMET	1 EA
109	104015	POWER SWITCH BEZEL	1 EA
110	110626	POWER SWITCH	1 EA

FRESH CUP 4 CONTROL BOARD

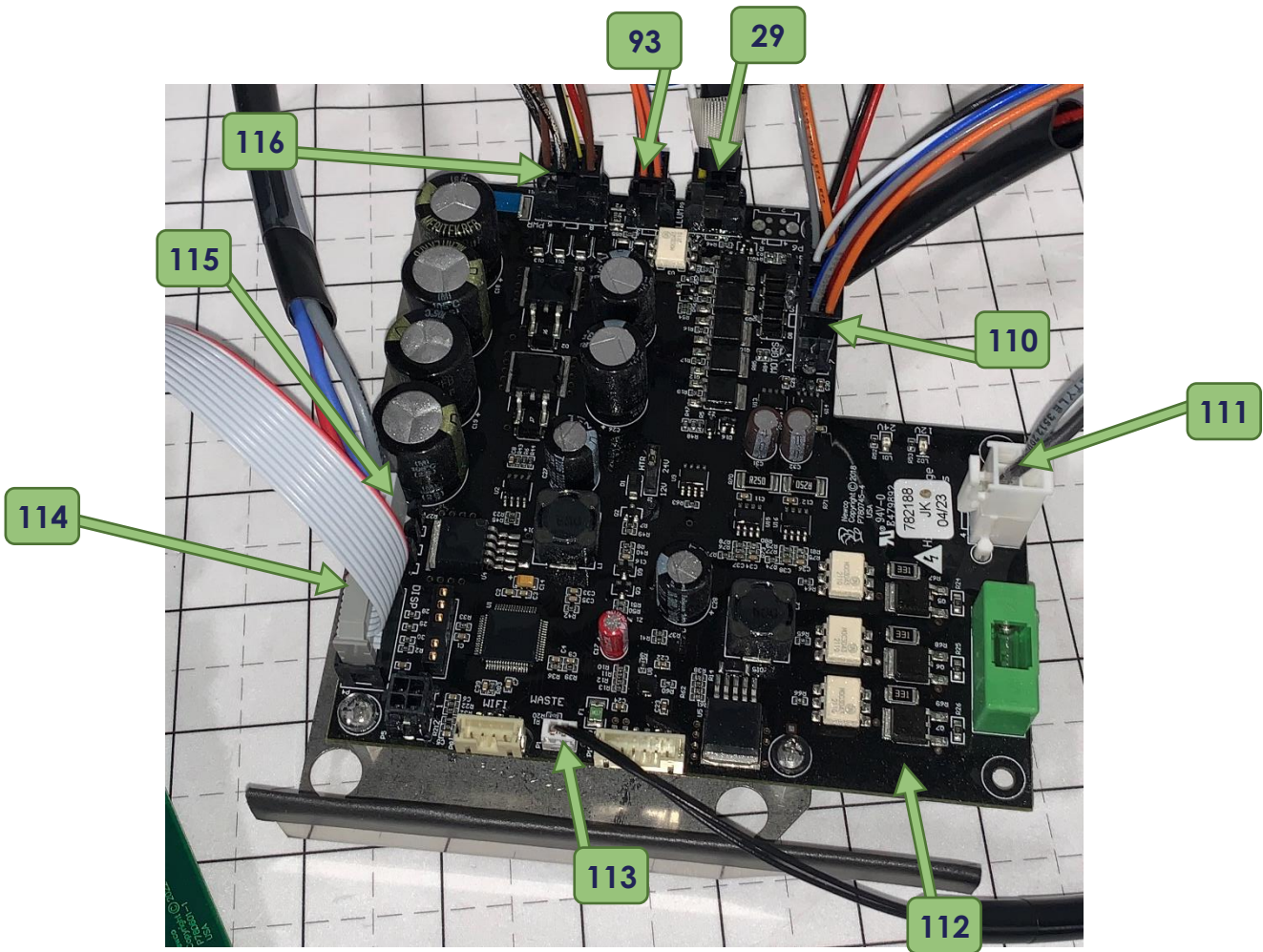

19	780357	BLUE LED WIRING HARNESS	1 EA
111	780290	DC MOTOR WIRING HARNESS	1 EA
113	782244	SOLENOID AND PUMP WIRING HARNESS	1 EA
114	780436	WASTE BIN SENSOR WIRING HARNESS	1 EA
115	780601	DISPLAY AND MOTOR WIRING HARNESS	1 EA
116	780683	FLOW METER WIRING HARNESS	1 EA
117	780410	TRANSFORMER WIRING HARNESS	1 EA
113	782187	CONTROL BOARD ASSEMBLY	1 EA

FRESH CUP 4 WIRING DIAGRAM

Wire colors subject to change.

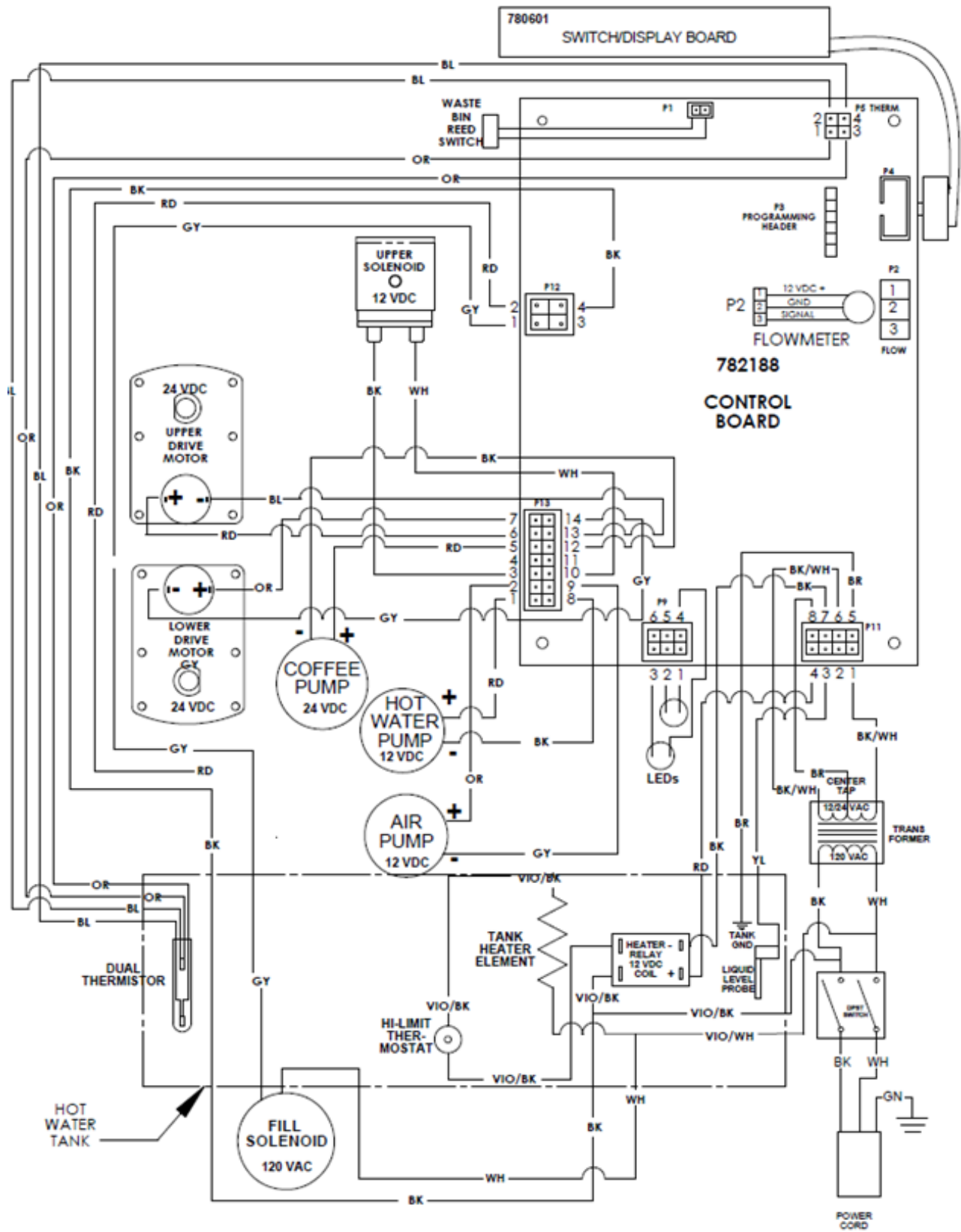

FRESH CUP TOUCH CONTROL BOARD

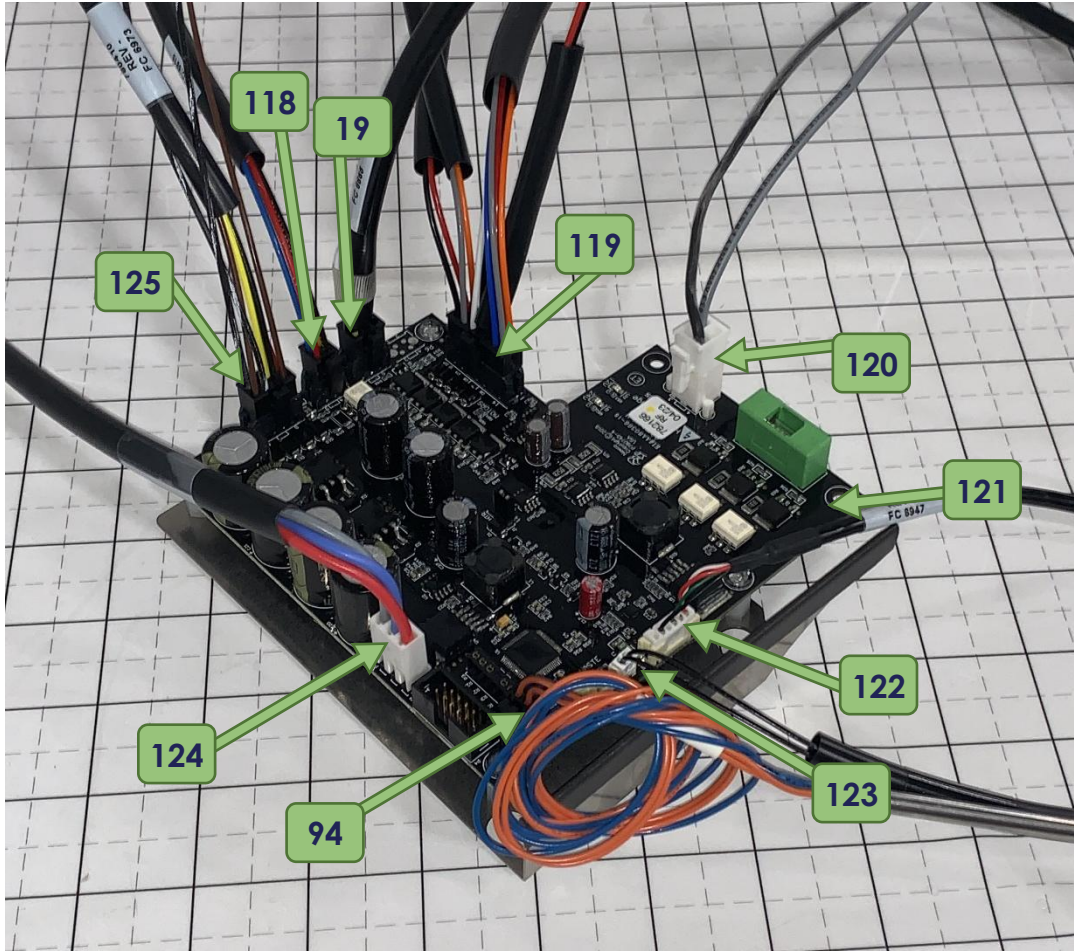

19	780357	BLUE LED WIRING HARNESS	1 EA
118	782154	COMMUNICATION WIRING HARNESS	1 EA
119	780290	DC MOTOR WIRING HARNESS	1 EA
121	782244	SOLENOID AND PUMP WIRING HARNESS	1 EA
122	780780	USB CABLE ASSEMBLY	1 EA
123	780436	WASTE BIN SENSOR WIRING HARNESS	1 EA
124	780683	FLOW METER WIRING HARNESS	1 EA
125	780410	TRANSFORMER WIRING HARNESS	1 EA
121	782165	CONTROL BOARD ASSEMBLY	1 EA

FRESH CUP TOUCH WIRING DIAGRAM

Wire colors subject to change.

